

USER MANUAL



RD-GB2A Bus Amplifier Nexa Modular GB2 2-Wire



INTRODUCTION

First and foremost we would like to thank you for purchasing this product.

Our commitment to achieving the satisfaction of customers like you is manifested through our ISO-9001 certification and the manufacture of products like the one you have just purchased.

Its advanced technology and strict quality control will ensure that customers and users enjoy the numerous features that this device offers. To get the most out of them and ensure proper operation from day one, we recommend that you read this instruction manual.

CONTENTS

Introduction.....	2
Contents.....	2
Set-up warnings.....	2
Safety precautions.....	2
Characteristics.....	3
RAP-2150 cable characteristics (Golmar).....	3
Operating modes.....	
Repeater mode.....	4
Router mode.....	5
Gateway mode.....	6
Description of the RD-GB2A Bus amplifier module.....	
Description.....	7
Installation.....	
Illustration of RD-GB2A Bus amplifier module installation.....	7
Description of the DIP switches.....	8-9
Description of the status LEDs.....	9
Description of the function buttons.....	9-10
Door panel call addresses and monitor addresses assigned to each RD-GB2A module.....	11-16
Configuring the button code (up to 32 addresses/apartments).....	17-20
Configuring the button code (up to 128 addresses/apartments).....	21-30
Wiring diagrams.....	
Installation of a video door entry system with the RD-GB2A module 'repeater' mode of the monitor bus.....	31
Installation of a video door entry system with the RD-GB2A module 'repeater' mode of the door panel bus.....	32
Installation of a video door entry system with RD-GB2A module 'router' mode (button/coded panel).....	33
Installation of a video door entry system with RD-GB2A module 'gateway' mode (interior button panel).....	34
Installation of a video door entry system with RD-GB2A module 'gateway' mode (interior coded panel).....	35
Installation of a video door entry system with 3 access panels.....	36
Connection of Golmar DC and AC lock releases.....	37

SET-UP WARNINGS

- Do not overtighten the screws on the RD-GB2A bus amplifier module connector.
- Before connecting the device, check the connections between the power supply unit, door panel, distributors, camera interface, GSM interface, monitors, telephones and hands-free audio terminals.
- Use the Golmar **RAP-2150** cable (2x1mm²).
- Always follow the instructions contained in this manual.

SAFETY PRECAUTIONS

- **Always disconnect the power supply** before installing or making modifications to the device
- The fitting and handling of this device must be carried out by **authorised personnel**.
- The wiring must run at least **40 cm away from any other wiring**.
- Install the RD-GB2A module in a dry protected location free from the risk of dripping or splashing water.
- Install the RD-GB2A module with an FA-GB2A power supply.
- Avoid locations that are humid, dusty or near heat sources.
- Ensure that the air vents are free from obstruction so that air can circulate freely.
- To prevent damage, the RD-GB2A module must be firmly secured in place.

CHARACTERISTICS

- RD-GB2A Bus amplifier module with simplified wiring (non-polarised 2-wire bus).
- RD-GB2A Bus amplifier module for the GB2 system that allows the following operating modes:
 - ☞ Repeater mode, enables the distance of the door panel bus or monitor bus to be increased when it exceeds 80 m (distance with Golmar RAP-2150 2x1mm² twisted pair cable).
 - ☞ Router mode, enables the installation to have 8 risers/verticals.
 - ☞ Gateway mode, enables an installation with one general entrance door panel and 8 buildings with interior door panels.
- In repeater mode:
 - ☞ Enables door panel bus or monitor bus distance to be increased when it exceeds 80m. (Distance with Golmar RAP-2150 twisted pair 2x1mm² cable).
 - ☞ The RD-GB2A module cannot be used as a repeater in installations with risers/verticals or general entrance door panels.
 - ☞ Only one RD-GB2A module as repeater per installation.
- In router mode, enables the installation to have 8 risers/verticals:
 - ☞ Up to 23 monitors and apartments with a Vesta2 monitor per riser. (Mixed inst. with telephones max. 23 elements).
 - ☞ Up to 18 monitors and apartments with a Vesta7 monitor per riser. (Mixed inst. with telephones max. 18 elements).
 - ☞ Up to 32 telephones and apartments with T562/Nhea telephones per riser (audio door entry system inst., audio only).
 - ☞ An RD-GB2A module is required with FA-GB2A power supply for each riser/column.
 - ☞ Up to 4 coded access panels with button access panels, see below:
 - Installation with 1 door panel with pushbuttons up to 128 apartments (double button)/71 apartments (single button).
 - Installation with 2 door panels with pushbuttons up to 64 apartments (double button)/31 apartments (single button) on each door panel.
 - Installation with 3 door panels with pushbuttons up to 42 apartments (double button)/21 apartments (single button) on each door panel.
 - Installation with 4 door panels with pushbuttons up to 32 apartments (double button)/16 apartments (single button) on each door panel.
 - ☞ The door panel(s) must have an EL632 GB2A sound module installed for compatibility with this operating mode.
- In gateway mode, enables a system with one general entrance door panel and up to 8 interior buildings.
 - ☞ Up to 23 monitors and apartments with a Vesta2 monitor per interior building. (Mixed installations with telephones max. 23 elements).
 - ☞ Up to 18 monitors and apartments with a Vesta7 monitor per interior building. (Mixed installations with telephones max. 18 elements).
 - ☞ Up to 32 telephones and apartments with T562/Nhea telephones per interior building (audio door entry system installation, audio only).
 - ☞ Up to 3 access door panels per interior building.
 - ☞ Up to 1 general entrance door panel. (**Note: To connect more than one general entrance door panel, consult our technical service department**).
 - ☞ Up to 8 interior buildings (each interior building up to 3 access panels).
 - ☞ An RD-GB2A module is required with FA-GB2A power supply for each interior building.
 - ☞ The door panel(s) must have an EL632 GB2A sound module installed for compatibility with this operating mode.
- Each RD-GB2A module requires an FA-GB2A power supply.
- It is necessary to configure the operating mode.
- DIP switches (operating mode, RD-GB2A module address number and end of line).
- Status LEDs.

RAP-2150 (GOLMAR) CABLE CHARACTERISTICS

CONSTRUCTION CHARACTERISTICS	VALUES
Flexible 1mm ² twisted pair polished copper conductor	Class V
Wiring	15 V/m

ELECTRICAL CHARACTERISTICS	VALUES
Electrical resistance of the conductor at 20°C	19.5 Ω/Km
Capacity between conductors	45pf/m ± 10%
Characteristic impedance	100 Ω ± 10%

OPERATING MODES

'Repeater' operating mode:

- This operating mode enables the distance of the door panel bus or monitor bus to be increased when it exceeds 80 m (distance with Golmar RAP-2150 2x1mm² twisted pair cable).
- The RD-GB2A module requires an FA-GB2A power supply.
- Install the RD-GB2A module with an FA-GB2A power supply.
- The RD-GB2A module cannot be used as a repeater in installations with risers/verticals or general entrance door panels.
- Only one RD-GB2A module as repeater per installation.

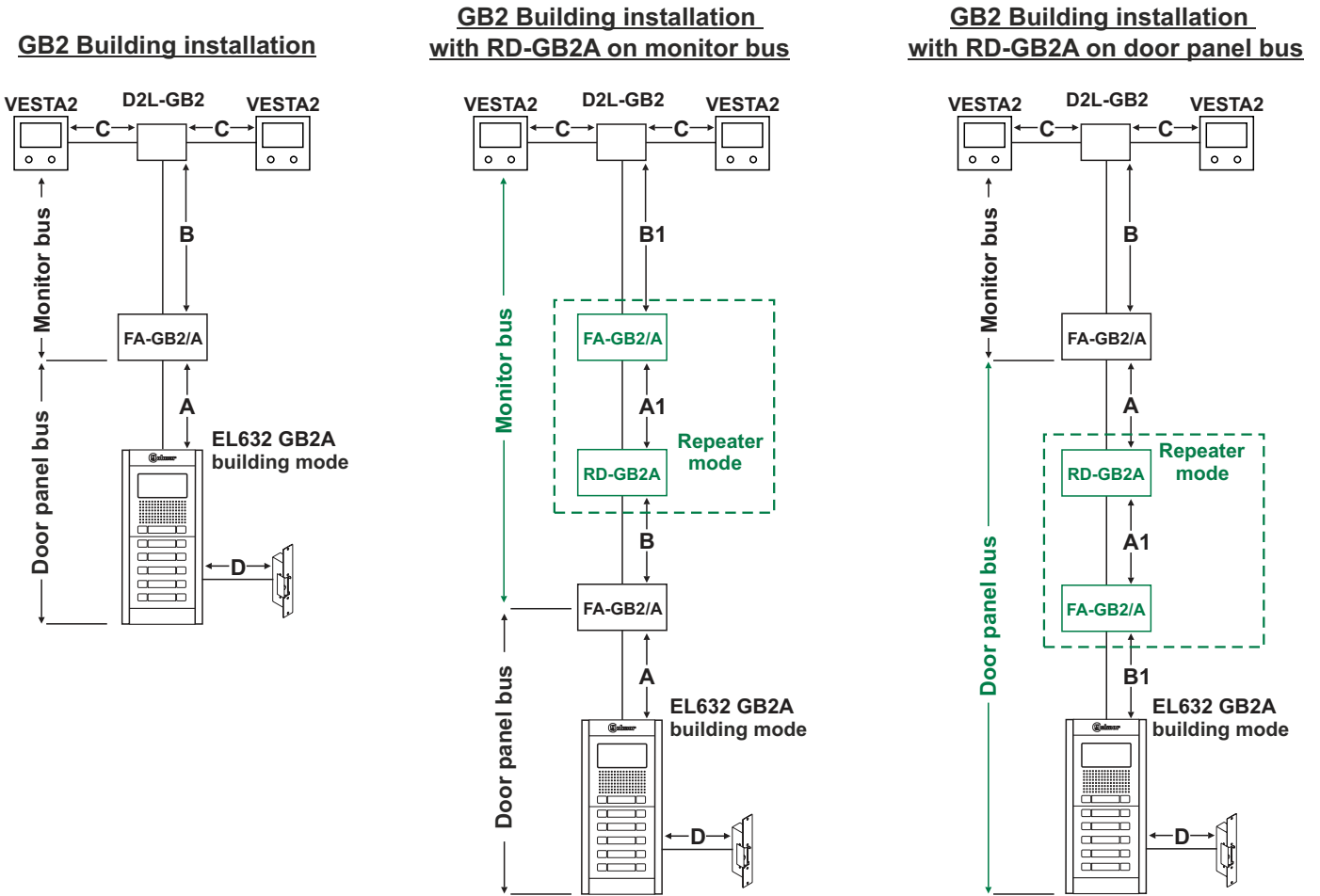

Distances and cross-sections

Cable	A	B	A1	B1	C	D
Twisted pair 2x0.75mm ²	60m	60m	1m	60m	30m	10m
(*)RAP-2150 (twisted pair 2x1mm ²)	80m	80m	1m	80m	40m	15m

(*) Distances with Golmar **RAP-2150** cable (twisted pair 2x1mm²).

IMPORTANT: For description, installation, configuration and programming of door panels and monitors, see the corresponding manuals.

OPERATING MODES

'Router' operating mode:

- This operating mode enables the installation to have up to 8 risers/verticals.
- One RD-GB2A module per riser/column.
 - ☞ Up to 23 monitors and apartments with a Vesta2 monitor per riser. (Mixed inst. with telephones max. 23 elements).
 - ☞ Up to 18 monitors and apartments with a Vesta7 monitor per riser. (Mixed inst. with telephones max. 18 elements).
 - ☞ Up to 32 telephones and apartments with T562/Nhea telephones per riser (audio door entry system installation, audio only).
- An RD-GB2A module is required with FA-GB2A power supply for each riser/column.
- Install the RD-GB2A module with an FA-GB2A power supply.
- The door panel(s) must have an EL632 GB2A sound module installed for compatibility with this operating mode.
- Up to 4 coded access panels with button access panels, see below:
 - ☞ Installation with 1 door panel with pushbuttons up to 128 apartments (double button)/72 apartments (single button).
 - ☞ Installation with 2 door panels with pushbuttons up to 62 apartments (double button)/31 apartments (single button) on each door panel.
 - ☞ Installation with 3 door panels with pushbuttons up to 42 apartments (double button)/21 apartments (single button) on each door panel.
 - ☞ Installation with 4 door panels with pushbuttons up to 32 apartments (double button)/16 apartments (single button) on each door panel.

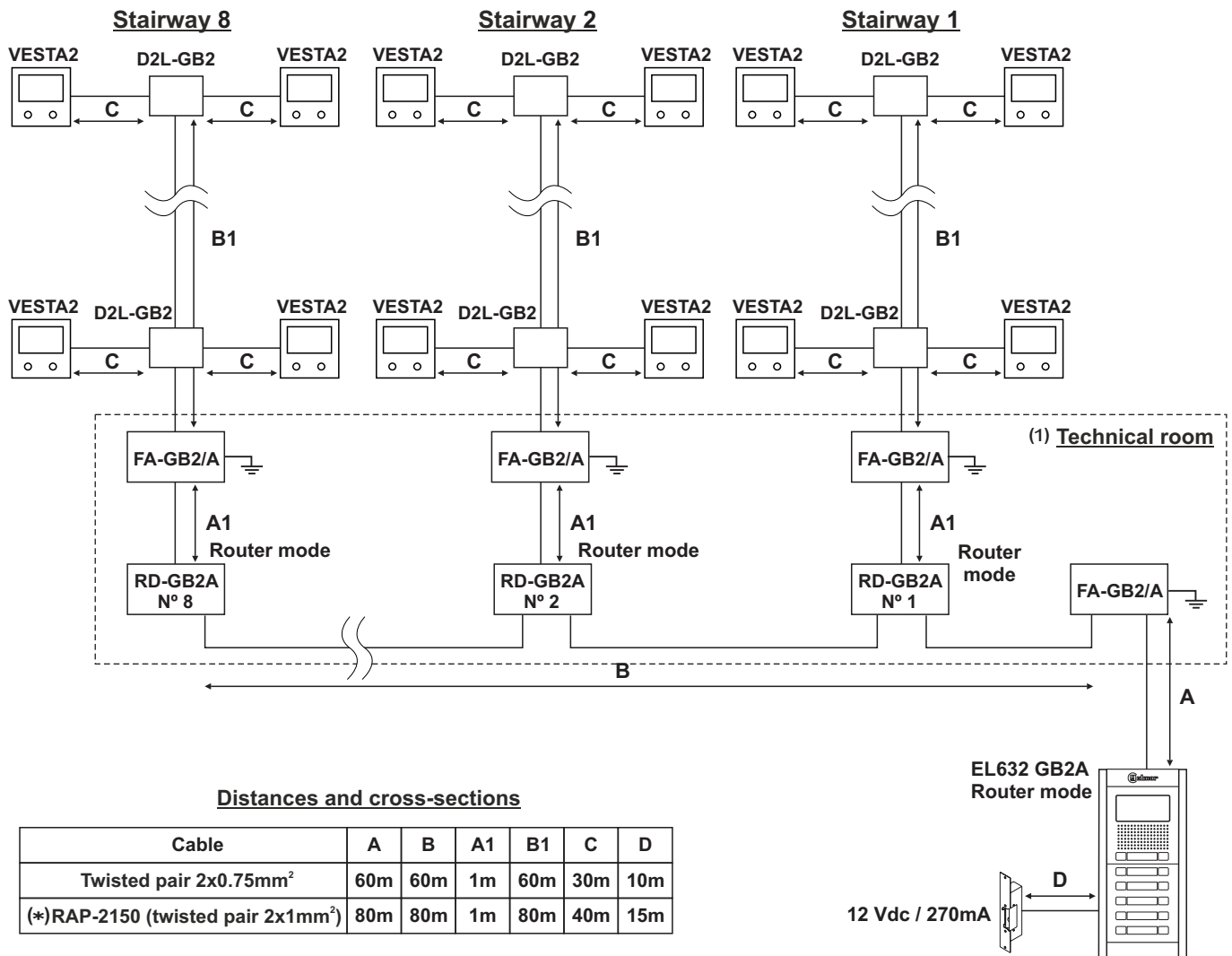

(*) Distances with Golmar **RAP-2150** cable (twisted pair 2x1mm²).

(1) It is recommended to install the RD-GB2A amplifiers and their respective FA-GB2A power supplies in a technical room. Connection between RD-GB2A amplifiers with a distance of 20cm.

IMPORTANT:

- For description, installation, configuration and programming of door panels and monitors, see the corresponding manuals.

OPERATING MODES

'Gateway' operating mode:

- This operating mode enables a system with one general entrance door panel and up to 8 interior buildings.
- One RD-GB2A amplifier per interior building.
 - ☞ Up to 23 monitors and apartments with a Vesta2 monitor per interior building. (Mixed installations with telephones max. 23 elements).
 - ☞ Up to 18 monitors and apartments with a Vesta7 monitor per interior building. (Mixed installations with telephones max. 18 elements).
 - ☞ Up to 32 telephones and apartments with T562/Nhea telephones per interior building (audio door entry system installation, audio only).
- An RD-GB2A module is required with FA-GB2A power supply for each interior building.
- Install the RD-GB2A module with an FA-GB2A power supply.
- The door panel must have an EL632 GB2A sound module installed for compatibility with this operating mode.
- Up to one general entrance door panel. (**Note: To connect more than one general entrance door panel, consult our technical service department**).
- Up to 8 interior buildings (each interior building up to 3 access panels).

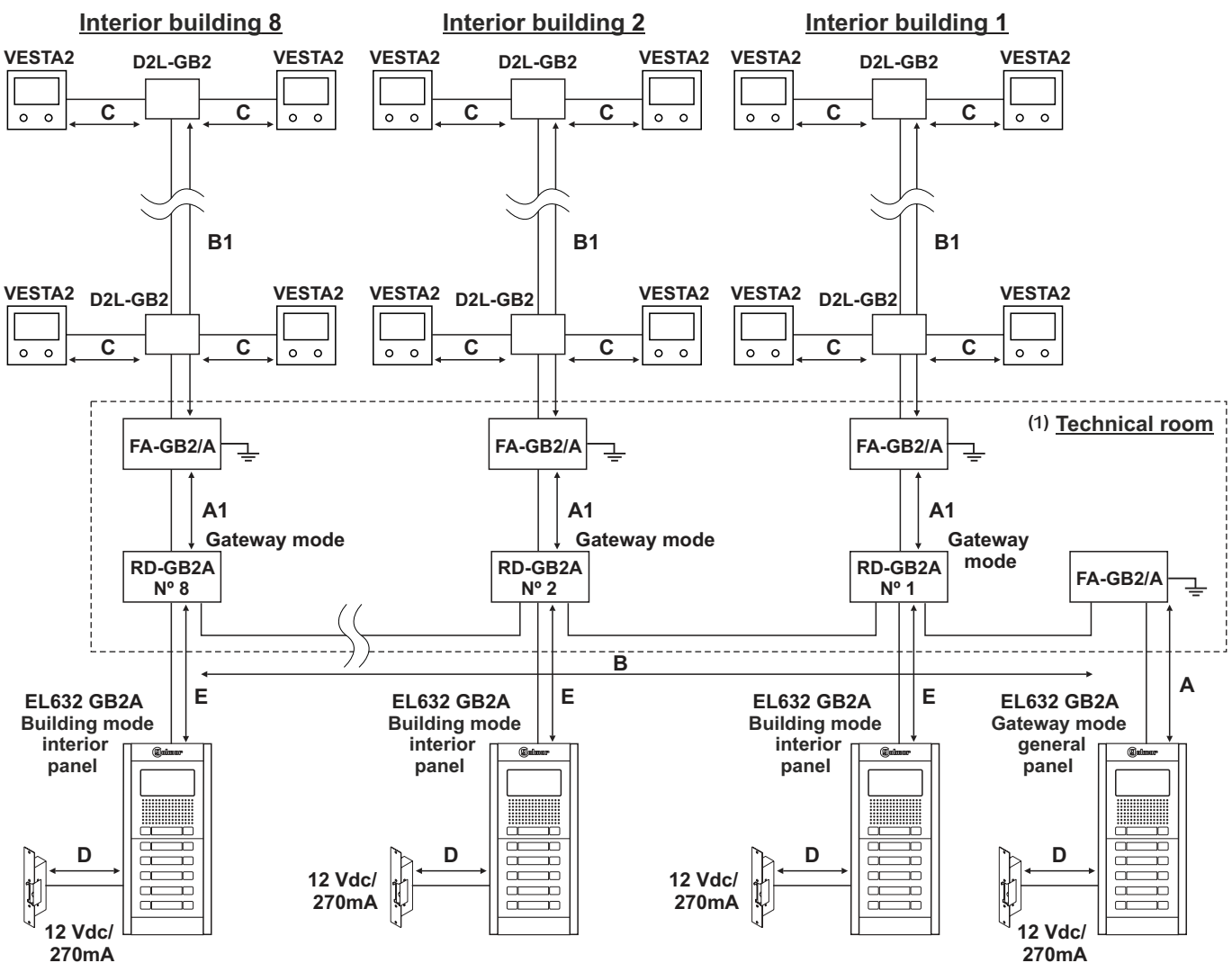

Distances and cross-sections

Cable	A	B	A1	B1	C	D	E
Twisted pair 2x0.75mm ²	60m	60m	1m	60m	30m	10m	60m
(*)RAP-2150 (twisted pair 2x1mm ²)	80m	80m	1m	80m	40m	15m	80m

(*) Distances with Golmar RAP-2150 cable (twisted pair 2x1mm²).

(1) It is recommended to install the RD-GB2A amplifiers and their respective FA-GB2A power supplies in a technical room. Connection between RD-GB2A amplifiers with a distance of 20cm.

IMPORTANT:

For description, installation, configuration and programming of door panels and monitors, see the corresponding manuals.

DESCRIPTION OF THE RD-GB2A BUS AMPLIFIER MODULE

Description:

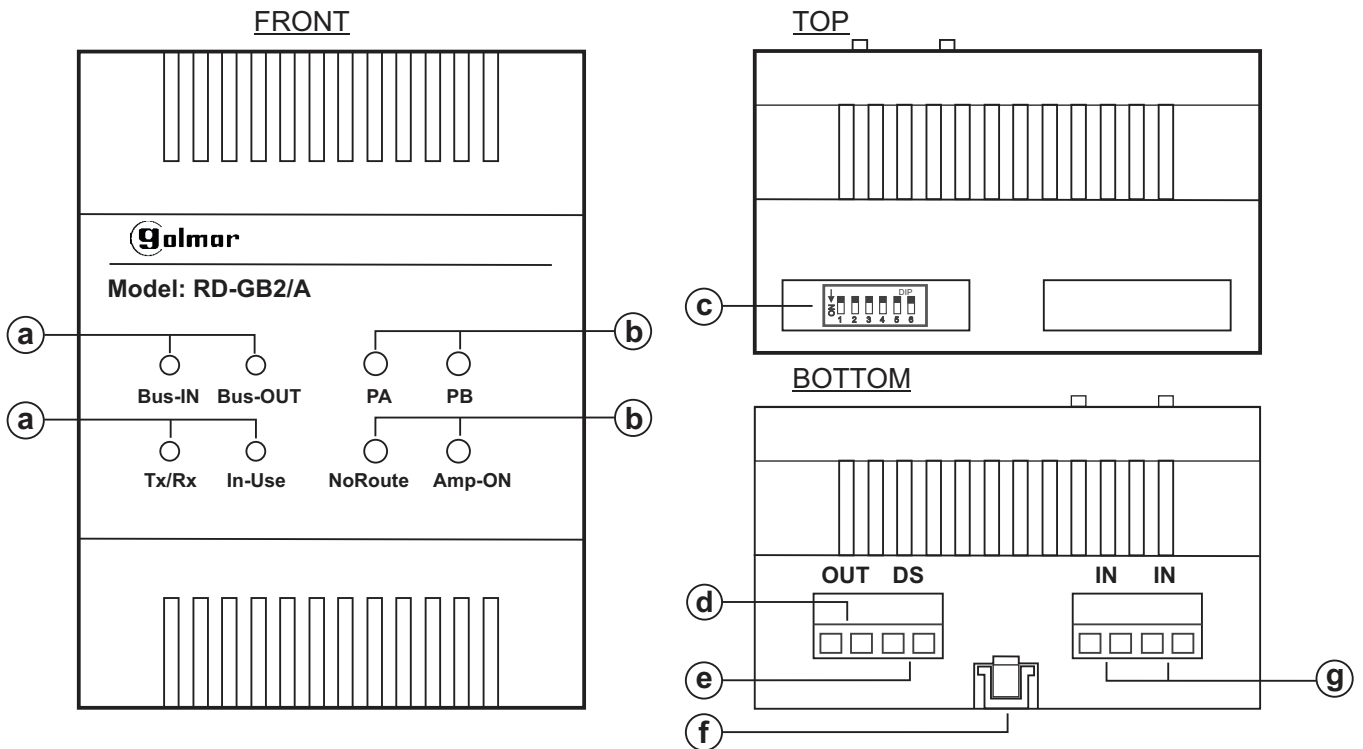

- a. Status LEDs.
- b. Configuration buttons
- c. Configuration DIP switch.
- d. Output terminals from the amplifier to the bus.

- e. Interior door panel connection terminals (general entrance door panel system).
- f. DIN rail latch release.
- g. Bus input terminals.

INSTALLATION

Illustration of RD-GB2A Bus amplifier module installation:

Install the RD-GB2A module in a dry protected location free from the risk of dripping or splashing water.
 Install the RD-GB2A module with an FA-GB2A power supply.

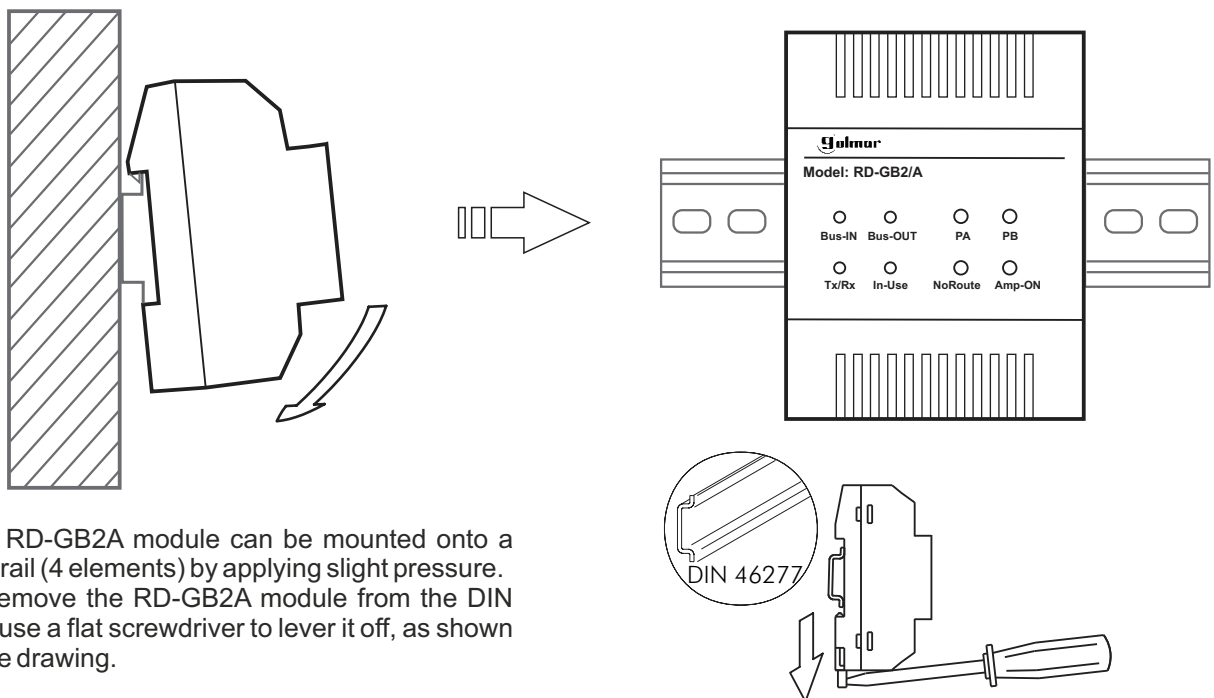

The RD-GB2A module can be mounted onto a DIN rail (4 elements) by applying slight pressure. To remove the RD-GB2A module from the DIN rail, use a flat screwdriver to lever it off, as shown in the drawing.

INSTALLATION

Description of the DIP switches:

The DIP switches of the RD-GB2A module enable configuration of one of the 3 operating modes, module address number and end of line.

- Repeater mode enables door panel bus or monitor bus distance to be increased when it exceeds 80 m.
- Router mode enables the installation to have up to 8 risers/columns.
- Gateway mode, enables an installation with one general entrance door panel and 7 buildings with interior door panels.

Configuring the operating mode:



Repeater mode:
DIP switches: 1 and 2 set to OFF.



Router mode:
DIP switches: 1 set to ON and 2 set to OFF.



Gateway mode:
DIP switches: 1 set to OFF and 2 set to ON.



No function.

Configuring the address number on the RD-GB2A module installed:

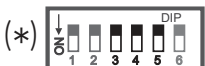

To configure the RD-GB2A module as No. 1: DIP switches 3, 4 and 5 set to OFF.
(1) -Button panel call addresses (0 to 31) for monitor address (0 to 31) respectively.
-Coded panel call addresses (1 to 32) for monitor address (0 to 31).
Note: Call address '32' on the coded panel calls the monitor with address '0'.



To configure the RD-GB2A module as No. 2: DIP switch 3 set to ON, 4 and 5 set to OFF.
(1) -Button panel call addresses (32 to 63) for monitor address (0 to 31) respectively.
-Coded panel call addresses (33 to 64) for monitor address (0 to 31).
Note: Call address '64' on the coded panel calls the monitor with address '0'.



To configure the RD-GB2A module as No. 3: DIP switch 3 set to OFF, 4 set to ON and 5 set to OFF.
(1) -Button panel call addresses (64 to 95) for monitor address (0 to 31) respectively.
-Coded panel call addresses (65 to 96) for monitor address (0 to 31).
Note: Call address '96' on the coded panel calls the monitor with address '0'.



To configure the RD-GB2A module as No. 4: DIP switches 3 and 4 set to ON and 5 set to OFF.
(1) -Button panel call addresses (96 to 127) for monitor address (0 to 31) respectively.
-Coded panel call addresses (97 to 128) for monitor address (0 to 31).
Note: Call address '128' on the coded panel calls the monitor with address '0'.

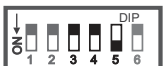

To configure the RD-GB2A module as No. 5: DIP switches 3 and 4 set to OFF and 5 set to ON.
(1) -Coded panel call addresses (129 to 160) for monitor address (0 to 31).
Note: Call address '160' on the coded panel calls the monitor with address '0'.



To configure the RD-GB2A module as No. 6: DIP switch 3 set to ON, 4 set to OFF and 5 set to ON.
(1) -Coded panel call addresses (161 to 192) for monitor address (0 to 31).
Note: Call address '192' on the coded panel calls the monitor with address '0'.



To configure the RD-GB2A module as No. 7: DIP switch 3 set to OFF, 4 and 5 set to ON.
(1) -Coded panel call addresses (193 to 224) for monitor address (0 to 31).
Note: Call address '224' on the coded panel calls the monitor with address '0'.



To configure the RD-GB2A module as No. 8: DIP switches: 3, 4 and 5 set to ON.
(1) -Coded panel call addresses (225 to 256) for monitor address (0 to 31).
Note: Call address '256' on the coded panel calls the monitor with address '0'.

IMPORTANT:

- Select a different address number for each RD-GB2A module.
- (1) - Each address number of the RD-GB2A has 32 different door panel call addresses assigned for each RD-GB2A module addressed. For further details see pages 11-16.
- (*) **Factory setting.**

Continued overleaf

INSTALLATION

Continued from previous page.

Configuring the end of line on the RD-GB2A module:



To configure the end of line of the RD-GB2A module:
DIP switch 6: Set the RD-GB2A module where the Bus cable ends (marked as 'IN' on the terminals) to ON.

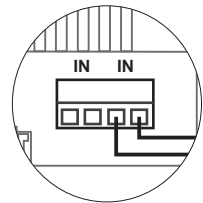

To configure the end of line of the RD-GB2A module:
DIP switch 6: Leave the intermediate modules in the OFF position.

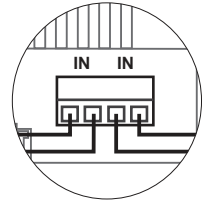

(*) **Factory setting.**

Description of the status LEDs:

The RD-GB2A module has the following status LEDs:

Bus In:

LED on: When the bus cable is connected to the 'IN' terminal.

Bus-Out:

LED on: When the monitor bus of the RD-GB2A module is connected.

TX/RX:

LED blinking: When the door panel is in communication with an RD-GB2A module monitor.

In-Use:

LED off: When the RD-GB2A module is in standby.

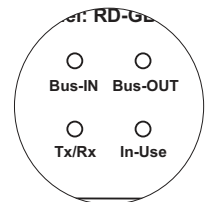

Description of the function buttons:

Displaying video gain:

To see the level of gain of the RD-GB2A module, press button on one of the monitors connected to the RD-GB2A module to be displayed (the image of the door panel will be displayed on the monitor). Note: The image should be displayed throughout the process.

Step 1: Press button on one of the monitors connected to the RD-GB2A module that requires video gain adjustment; the 'In-Use' LED will illuminate.

Step 2: Press the 'NoRoute' button to show, through the status LEDs, the level of gain of the RD-GB2A module; see table:

Function buttons

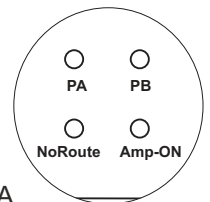

Video gain

	Bus-IN LED	Bus-OUT LED	Tx/Rx LED
(*) Gain 1	ON	OFF	OFF
Gain 2	OFF	ON	OFF
Gain 3	ON	ON	OFF
Gain 4	OFF	OFF	ON
Gain 5	ON	OFF	ON
Gain 6	OFF	ON	ON

Status LEDs

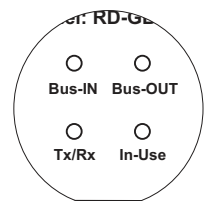

Note: Gain level from 1 to 6, with 1 the minimum value and 6 the maximum.

(*) **Factory setting.**

INSTALLATION

Continued from previous page.

Adjusting video gain:

To adjust the gain of the RD-GB2A module, press button  on one of the monitors connected to the RD-GB2A module to be displayed (the image of the door panel will be displayed on the monitor). Note: The image should be displayed throughout the process.

Step 1: Press button  on one of the monitors connected to the RD-GB2A module that requires video gain adjustment; the 'In-Use' LED will illuminate. (Note: RD-GB2A in gateway mode, establish communication with the general entrance door panel).

Step 2: Press button PA or PB to reduce or increase the gain level of the RD-GB2A module respectively. The status LEDs will indicate the modified gain level; see table:

		Video gain		
		Bus-IN LED	Bus-OUT LED	Tx/Rx LED
(*)	Gain 1	ON	OFF	OFF
	Gain 2	OFF	ON	OFF
	Gain 3	ON	ON	OFF
	Gain 4	OFF	OFF	ON
	Gain 5	ON	OFF	ON
	Gain 6	OFF	ON	ON

Note: Gain level from 1 to 6, with 1 the minimum value and 6 the maximum.

(*) Factory setting.

Step 3: Then, to save the selected gain value, press the 'NoRoute' button for 3 seconds; the 'In-Use' LED will blink.

Step 4: Press the 'NoRoute' button again for 3 seconds until the LED illuminates. This indicates that the RD-GB2A module is operating with the gain value set in the previous steps in 'fixed mode' (always).

Step 5: Check that the new gain value is correct. With the monitor video activated, press the 'NoRoute' button and check that the status LEDs indicate the required gain value (see video gain table in step 2).

Note: Repeat the procedure (steps 1 to 5) until the RD-GB2A module is set to the required video gain

Set the video gain to 'fixed' or 'automatic' mode:

The RD-GB2A module has 2 operating modes for setting gain:

'Fixed' mode: The RD-GB2A module will always use the gain configured in the module.

Step 1: Press button  on one of the monitors connected to the RD-GB2A module that requires video gain adjustment; the 'In-Use' LED will illuminate. (Note: RD-GB2A in gateway mode, establish communication with the general entrance door panel).

Step 2: Then press the 'NoRoute' button for 3 seconds and repeat this step until the 'In-Use' status LED illuminates.

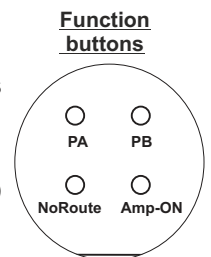

'Automatic' mode: The RD-GB2A module adjusts the gain automatically when it connects to the system.

Step 1: Press button  on one of the monitors connected to the RD-GB2A module that requires adjustment to 'automatic' mode; the 'In-Use' LED will illuminate.

Step 2: Then press the 'NoRoute' button for 3 seconds and repeat this step until the 'In-Use' status LED is blinking.

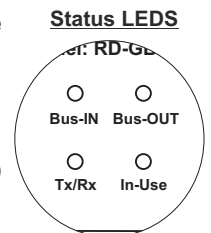

Default settings:

To use the default settings of the RD-GB2A module (level 1 gain and 'fixed' mode):

































Step 1: Disconnect the module from the power supply.

Step 2: Reconnect the module to the power supply. Then, during the first 10 seconds, with the RD-GB2A module in standby, press the 'NoRoute' button for 3 seconds; the 'In-Use' status LED will blink once confirming that the module is now using the default settings.

INSTALLATION



Door panel call addresses and monitor addresses assigned to each RD-GB2A module:

RD-GB2A module No. 1

<u>Monitor address</u>	<u>Button panel address</u>	<u>Monitor address</u>	<u>Coded panel address</u>
(*) 0	Button 'P1' EL632 GB2A module	(*) 0	Button 'P1' EL632 GB2A module
1	Button 'P2' EL632 GB2A module	1	Button 'P2' EL632 GB2A module
		(*) 0	32 + 
		1	1 + 
	<u>EL610D module No. 1.</u>		
2	Button "P2" (Add. 2)	2	2 + 
3	Button "P3" (Add. 3)	3	3 + 
4	Button "P4" (Add. 4)	4	4 + 
5	Button "P5" (Add. 5)	5	5 + 
6	Button "P6" (Add. 6)	6	6 + 
7	Button "P7" (Add. 7)	7	7 + 
8	Button "P8" (Add. 8)	8	8 + 
9	Button "P9" (Add. 9)	9	9 + 
10	Button "P10" (Add. 10)	10	10 + 
11	Button "P1" (Add. 11)	11	11 + 
	<u>EL610D module No. 2</u>		
12	Button "P2" (Add. 12)	12	12 + 
13	Button "P3" (Add. 13)	13	13 + 
14	Button "P4" (Add. 14)	14	14 + 
15	Button "P5" (Add. 15)	15	15 + 
16	Button "P6" (Add. 16)	16	16 + 
17	Button "P7" (Add. 17)	17	17 + 
18	Button "P8" (Add. 18)	18	18 + 
19	Button "P9" (Add. 19)	19	19 + 
20	Button "P10" (Add. 20)	20	20 + 
21	Button "P1" (Add. 21)	21	21 + 
	<u>EL610D module No. 3</u>		
22	Button "P2" (Add. 22)	22	22 + 
23	Button "P3" (Add. 23)	23	23 + 
24	Button "P4" (Add. 24)	24	24 + 
25	Button "P5" (Add. 25)	25	25 + 
26	Button "P6" (Add. 26)	26	26 + 
27	Button "P7" (Add. 27)	27	27 + 
28	Button "P8" (Add. 28)	28	28 + 
29	Button "P9" (Add. 29)	29	29 + 
30	Button "P10" (Add. 30)	30	30 + 
31	Button "P1" (Add. 31)	31	31 + 

(*) IMPORTANT:

-In door panel systems with call buttons, the first address on the monitor is 'Code 0'.

-In coded panel systems (N3301/GB2), on **RD-GB2A module No. 1**, 'code 0' is 'code 32', which means that when a call is made to a monitor with 'code 0' (DIP 1 to DIP 5 set to OFF),    needs to be entered on the N3301/GB2 numeric keypad.

-In the software (Address Manager GB2) of the EL632-GB2A module, button P1 with call 'code 0' is also shown as 'code 32'.

































NOTE: For description, installation, configuration and programming of door panels and monitors, see the corresponding manuals.

Continued overleaf



INSTALLATION

Continued from previous page.

RD-GB2A module No. 2

<u>Monitor address</u>	<u>Button panel address</u>	<u>Monitor address</u>	<u>Coded panel address</u>
<u>EL610D module No. 4.</u>			
0	Button "P2" (Add. 32)	(*) 0	64 + 
1	Button "P3" (Add. 33)	1	33 + 
2	Button "P4" (Add. 34)	2	34 + 
3	Button "P5" (Add. 35)	3	35 + 
4	Button "P6" (Add. 36)	4	36 + 
5	Button "P7" (Add. 37)	5	37 + 
6	Button "P8" (Add. 38)	6	38 + 
7	Button "P9" (Add. 39)	7	39 + 
8	Button "P10" (Add. 40)	8	40 + 
9	Button "P1" (Add. 41)	9	41 + 
<u>EL610D module No. 5</u>			
10	Button "P2" (Add. 42)	10	42 + 
11	Button "P3" (Add. 43)	11	43 + 
12	Button "P4" (Add. 44)	12	44 + 
13	Button "P5" (Add. 45)	13	45 + 
14	Button "P6" (Add. 46)	14	46 + 
15	Button "P7" (Add. 47)	15	47 + 
16	Button "P8" (Add. 48)	16	48 + 
17	Button "P9" (Add. 49)	17	49 + 
18	Button "P10" (Add. 50)	18	50 + 
19	Button "P1" (Add. 51)	19	51 + 
<u>EL610D module No. 6</u>			
20	Button "P2" (Add. 52)	20	52 + 
21	Button "P3" (Add. 53)	21	53 + 
22	Button "P4" (Add. 54)	22	54 + 
23	Button "P5" (Add. 55)	23	55 + 
24	Button "P6" (Add. 56)	24	56 + 
25	Button "P7" (Add. 57)	25	57 + 
26	Button "P8" (Add. 58)	26	58 + 
27	Button "P9" (Add. 59)	27	59 + 
28	Button "P10" (Add. 60)	28	60 + 
29	Button "P1" (Add. 61)	29	61 + 
<u>EL610D module No. 7</u>			
30	Button "P2" (Add. 62)	30	62 + 
31	Button "P3" (Add. 63)	31	63 + 

(*) IMPORTANT:

-In coded panel systems (N3301/GB2), on **RD-GB2A module No. 2**, to make a call to a monitor with 'code 0' (DIP 1 to DIP 5 set to OFF),    needs to be entered on the N3301/GB2 numeric keypad.

































NOTE: For description, installation, configuration and programming of door panels and monitors, see the corresponding manuals.

Continued overleaf



INSTALLATION

Continued from previous page.

RD-GB2A module No. 3

<u>Monitor address</u>	<u>Button panel address</u>	<u>Monitor address</u>	<u>Coded panel address</u>
<u>EL610D module No. 7</u>			
0	Button "P4" (Add. 64)	(*) 0	96 + 
1	Button "P5" (Add. 65)	1	65 + 
2	Button "P6" (Add. 66)	2	66 + 
3	Button "P7" (Add. 67)	3	67 + 
4	Button "P8" (Add. 68)	4	68 + 
5	Button "P9" (Add. 69)	5	69 + 
6	Button "P10" (Add. 70)	6	70 + 
7	Button "P1" (Add. 71)	7	71 + 
<u>EL610D module No. 8</u>			
8	Button "P2" (Add. 72)	8	72 + 
9	Button "P3" (Add. 73)	9	73 + 
10	Button "P4" (Add. 74)	10	74 + 
11	Button "P5" (Add. 75)	11	75 + 
12	Button "P6" (Add. 76)	12	76 + 
13	Button "P7" (Add. 77)	13	77 + 
14	Button "P8" (Add. 78)	14	78 + 
15	Button "P9" (Add. 79)	15	79 + 
16	Button "P10" (Add. 80)	16	80 + 
17	Button "P1" (Add. 81)	17	81 + 
<u>EL610D module No. 9</u>			
18	Button "P2" (Add. 82)	18	82 + 
19	Button "P3" (Add. 83)	19	83 + 
20	Button "P4" (Add. 84)	20	84 + 
21	Button "P5" (Add. 85)	21	85 + 
22	Button "P6" (Add. 86)	22	86 + 
23	Button "P7" (Add. 87)	23	87 + 
24	Button "P8" (Add. 88)	24	88 + 
25	Button "P9" (Add. 89)	25	89 + 
26	Button "P10" (Add. 90)	26	90 + 
27	Button "P1" (Add. 91)	27	91 + 
<u>EL610D module No. 10</u>			
28	Button "P2" (Add. 92)	28	92 + 
29	Button "P3" (Add. 93)	29	93 + 
30	Button "P4" (Add. 94)	30	94 + 
31	Button "P5" (Add. 95)	31	95 + 

(*) **IMPORTANT:**

-In coded panel systems (N3301/GB2), on **RD-GB2A module No. 3**, to make a call to a monitor with 'code 0' (DIP 1 to DIP 5 set to OFF),    needs to be entered on the N3301/GB2 numeric keypad.

































NOTE: For description, installation, configuration and programming of door panels and monitors, see the corresponding manuals.

Continued overleaf





INSTALLATION

Continued from previous page.

RD-GB2A module No. 4

<u>Monitor address</u>	<u>Button panel address</u>	<u>Monitor address</u>	<u>Coded panel address</u>
<u>EL610D module No. 10</u>			
0	Button "P6" (Add. 96)	(*) 0	128 + 
1	Button "P7" (Add. 97)	1	97 + 
2	Button "P8" (Add. 98)	2	98 + 
3	Button "P9" (Add. 99)	3	99 + 
4	Button "P10" (Add. 100)	4	100 + 
5	Button "P1" (Add. 101)	5	101 + 
<u>EL610D module No. 11</u>			
6	Button "P2" (Add. 102)	6	102 + 
7	Button "P3" (Add. 103)	7	103 + 
8	Button "P4" (Add. 104)	8	104 + 
9	Button "P5" (Add. 105)	9	105 + 
10	Button "P6" (Add. 106)	10	106 + 
11	Button "P7" (Add. 107)	11	107 + 
12	Button "P8" (Add. 108)	12	108 + 
13	Button "P9" (Add. 109)	13	109 + 
14	Button "P10" (Add. 110)	14	110 + 
15	Button "P1" (Add. 111)	15	111 + 
<u>EL610D module No. 12</u>			
16	Button "P2" (Add. 112)	16	112 + 
17	Button "P3" (Add. 113)	17	113 + 
18	Button "P4" (Add. 114)	18	114 + 
19	Button "P5" (Add. 115)	19	115 + 
20	Button "P6" (Add. 116)	20	116 + 
21	Button "P7" (Add. 117)	21	117 + 
22	Button "P8" (Add. 118)	22	118 + 
23	Button "P9" (Add. 119)	23	119 + 
24	Button "P10" (Add. 120)	24	120 + 
25	Button "P1" (Add. 121)	25	121 + 
<u>EL610D module No. 13</u>			
26	Button "P2" (Add. 122)	26	122 + 
27	Button "P3" (Add. 123)	27	123 + 
28	Button "P4" (Add. 124)	28	124 + 
29	Button "P5" (Add. 125)	29	125 + 
30	Button "P6" (Add. 126)	30	126 + 
31	Button "P7" (Add. 127)	31	127 + 

(*) IMPORTANT:

-In coded panel systems (N3301/GB2), on **RD-GB2A module No. 4**, to make a call to a monitor with 'code 0' (DIP 1 to DIP 5 set to OFF),     needs to be entered on the N3301/GB2 numeric keypad.

NOTE: For description, installation, configuration and programming of door panels and monitors, see the corresponding manuals.

Continued overleaf

INSTALLATION

Continued from previous page.

RD-GB2A module No. 5**RD-GB2A module No. 6**

<u>Monitor address</u>	<u>Coded panel address</u>	<u>Monitor address</u>	<u>Coded panel address</u>
(*) 0	160 + Δ	(*) 0	192 + Δ
1	129 + Δ	1	161 + Δ
2	130 + Δ	2	162 + Δ
3	131 + Δ	3	163 + Δ
4	132 + Δ	4	164 + Δ
5	133 + Δ	5	165 + Δ
6	134 + Δ	6	166 + Δ
7	135 + Δ	7	167 + Δ
8	136 + Δ	8	168 + Δ
9	137 + Δ	9	169 + Δ
10	138 + Δ	10	170 + Δ
11	139 + Δ	11	171 + Δ
12	140 + Δ	12	172 + Δ
13	141 + Δ	13	173 + Δ
14	142 + Δ	14	174 + Δ
15	143 + Δ	15	175 + Δ
16	144 + Δ	16	176 + Δ
17	145 + Δ	17	177 + Δ
18	146 + Δ	18	178 + Δ
19	147 + Δ	19	179 + Δ
20	148 + Δ	20	180 + Δ
21	149 + Δ	21	181 + Δ
22	150 + Δ	22	182 + Δ
23	151 + Δ	23	183 + Δ
24	152 + Δ	24	184 + Δ
25	153 + Δ	25	185 + Δ
26	154 + Δ	26	186 + Δ
27	155 + Δ	27	187 + Δ
28	156 + Δ	28	188 + Δ
29	157 + Δ	29	189 + Δ
30	158 + Δ	30	190 + Δ
31	159 + Δ	31	191 + Δ

(*) IMPORTANT:

-In coded panel systems (N3301/GB2), on **RD-GB2A module No. 5**, to make a call to a monitor with 'code 0' (DIP 1 to DIP 5 set to OFF), **1 6 0 Δ** needs to be entered on the N3301/GB2 numeric keypad.

-In coded panel systems (N3301/GB2), on **RD-GB2A module No. 6**, to make a call to a monitor with 'code 0' (DIP 1 to DIP 5 set to OFF), **1 9 2 Δ** needs to be entered on the N3301/GB2 numeric keypad.

































































NOTE: For description, installation, configuration and programming of door panels and monitors, see the corresponding manuals.

Continued overleaf





INSTALLATION





Continued from previous page.

RD-GB2A module No. 7**RD-GB2A module No. 8**

<u>Monitor address</u>	<u>Coded panel address</u>	<u>Monitor address</u>	<u>Coded panel address</u>
(*) 0	224 + 	(*) 0	256 + 
1	193 + 	1	225 + 
2	194 + 	2	226 + 
3	195 + 	3	227 + 
4	196 + 	4	228 + 
5	197 + 	5	229 + 
6	198 + 	6	230 + 
7	199 + 	7	231 + 
8	200 + 	8	232 + 
9	201 + 	9	233 + 
10	202 + 	10	234 + 
11	203 + 	11	235 + 
12	204 + 	12	236 + 
13	205 + 	13	237 + 
14	206 + 	14	238 + 
15	207 + 	15	239 + 
16	208 + 	16	240 + 
17	209 + 	17	241 + 
18	210 + 	18	242 + 
19	211 + 	19	243 + 
20	212 + 	20	244 + 
21	213 + 	21	245 + 
22	214 + 	22	246 + 
23	215 + 	23	247 + 
24	216 + 	24	248 + 
25	217 + 	25	249 + 
26	218 + 	26	250 + 
27	219 + 	27	251 + 
28	220 + 	28	252 + 
29	221 + 	29	253 + 
30	222 + 	30	254 + 
31	223 + 	31	255 + 

(*) IMPORTANT:

-In coded panel systems (N3301/GB2), on **RD-GB2A module No. 7**, to make a call to a monitor with 'code 0' (DIP 1 to DIP 5 set to OFF),     needs to be entered on the N3301/GB2 numeric keypad.

-In coded panel systems (N3301/GB2), on **RD-GB2A module No. 8**, to make a call to a monitor with 'code 0' (DIP 1 to DIP 5 set to OFF),     needs to be entered on the N3301/GB2 numeric keypad.

NOTE: For description, installation, configuration and programming of door panels and monitors, see the corresponding manuals.

INSTALLATION

Configuring the button code (up to 32 addresses/apartments)

The EL610D button module needs to be configured in order to assign a call code to the buttons. Carry out this configuration with the DIP switch located at the back of the module.

Depending on the configuration option selected, the buttons will be assigned with a certain call code.

To configure the call code on the monitors. It is worth noting the call code of each button, as shown in the table below.

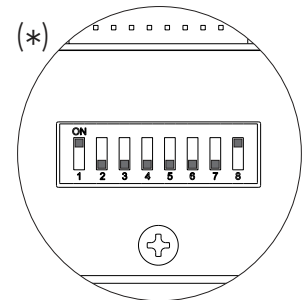

EL610D button module
Double button module codes

		DIP switch								Button code									
		Dip1	Dip2	Dip3	Dip4	Dip5	Dip6	Dip7	Dip8	P1	P2	P3	P4	P5	P6	P7	P8	P9	P10
Module configuration option	1	On	Off	Off	Off	Off	Off	Off	On	11	2	3	4	5	6	7	8	9	10
	2	Off	On	Off	Off	Off	Off	Off	On	21	12	13	14	15	16	17	18	19	20
	3	Off	Off	On	Off	Off	Off	Off	On	31	22	23	24	25	26	27	28	29	30

Single button module codes

		Dip1	Dip2	Dip3	Dip4	Dip5	Dip6	Dip7	Dip8	P1	P3	P5	P7	P9
		Module configuration option	1	On	Off	Off	Off	Off	Off	Off	On	1	2	3
2	Off		On	Off	Off	Off	Off	Off	On	6	7	8	9	10
3	Off		Off	On	Off	Off	Off	Off	On	11	12	13	14	15
4	Off		Off	Off	On	Off	Off	Off	On	16	17	18	19	20
5	Off		Off	Off	Off	On	Off	Off	On	21	22	23	24	25
6	Off		Off	Off	Off	Off	On	Off	On	26	27	28	29	30
7	Off		Off	Off	Off	Off	Off	On	On	31	-	-	-	-

(1) P1- P10: Button 1 - button 10.

Important: Select a different configuration option for each EL610D module.

(*) **Factory setting.**

IMPORTANTE:

For description, installation, configuration and programming of the door panel, EL610D module and monitors, see the manuals supplied with the respective door panel and monitors.

INSTALLATION

Configuring double button module codes:

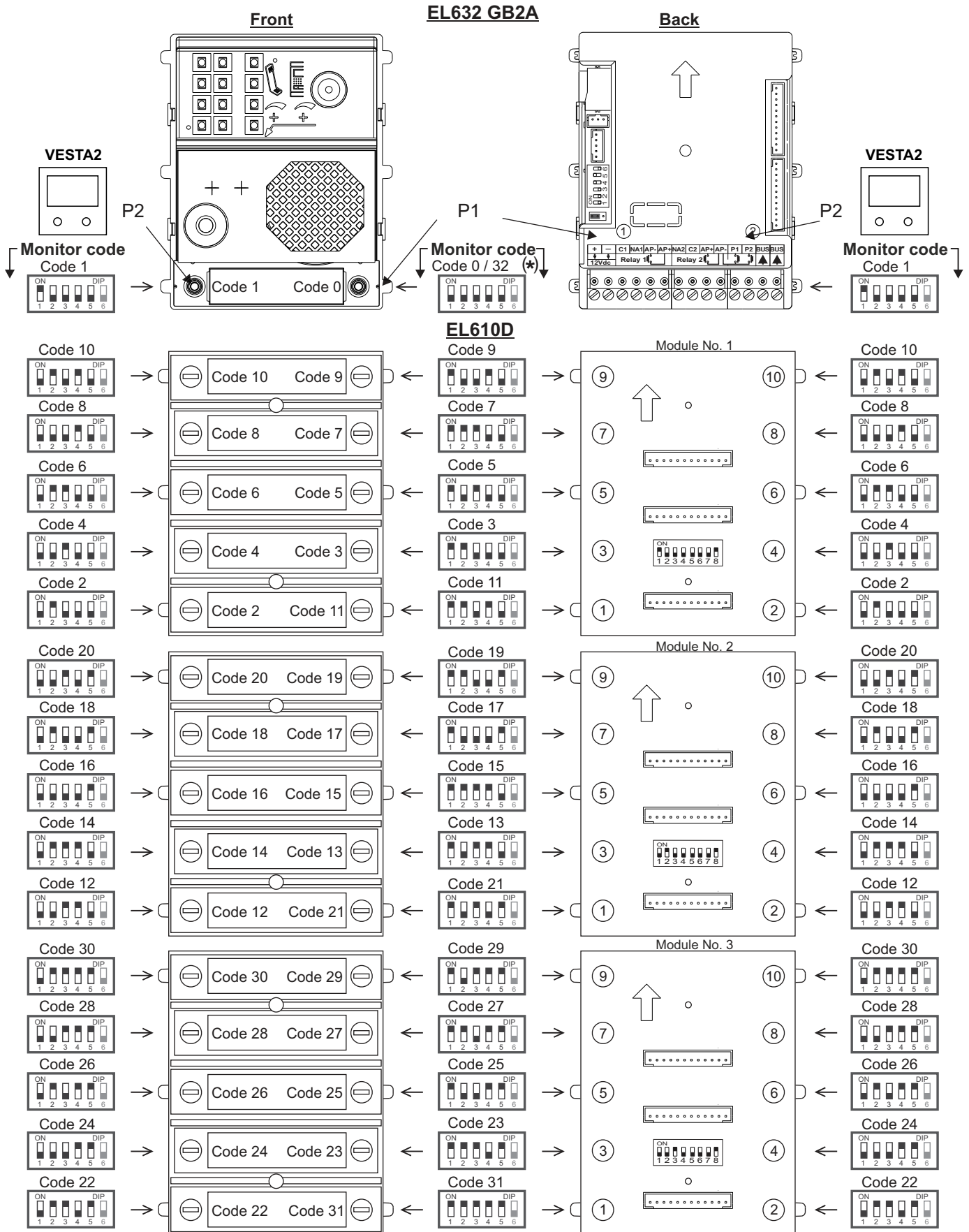

(*) -In door panel systems with call buttons, the first address on the monitor is 'Code 0'.

-In the software (Address Manager GB2), call 'code 0' of button 'P1' on the sound module is also shown as 'code 32'.

INSTALLATION

Configuring the button code (up to 128 addresses/apartments)

The EL610D button module needs to be configured in order to assign a call code to the buttons. Carry out this configuration with the DIP switch located at the back of the module.

Depending on the configuration option selected, the buttons will be assigned with a certain call code.

To configure the call code on the monitors. It is worth noting the call code of each button, as shown in the table below.

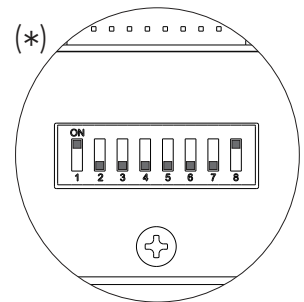

EL610D button module

Double button module codes

		DIP switch								Button code									
		Dip1	Dip2	Dip3	Dip4	Dip5	Dip6	Dip7	Dip8	P1	P2	P3	P4	P5	P6	P7	P8	P9	P10
Module configuration option	1	On	Off	Off	Off	Off	Off	Off	On	11	2	3	4	5	6	7	8	9	10
	2	Off	On	Off	Off	Off	Off	Off	On	21	12	13	14	15	16	17	18	19	20
	3	Off	Off	On	Off	Off	Off	Off	On	31	22	23	24	25	26	27	28	29	30
	4	Off	Off	Off	On	Off	Off	Off	On	41	32	33	34	35	36	37	38	39	40
	5	Off	Off	Off	Off	On	Off	Off	On	51	42	43	44	45	46	47	48	49	50
	6	Off	Off	Off	Off	Off	On	Off	On	61	52	53	54	55	56	57	58	59	60
	7	Off	Off	Off	Off	Off	Off	On	On	71	62	63	64	65	66	67	68	69	70
	8	On	Off	Off	Off	Off	Off	Off	Off	81	72	73	74	75	76	77	78	79	80
	9	Off	On	Off	Off	Off	Off	Off	Off	91	82	83	84	85	86	87	88	89	90
	10	Off	Off	On	Off	Off	Off	Off	Off	101	92	93	94	95	96	97	98	99	100
	11	Off	Off	Off	On	Off	Off	Off	Off	111	102	103	104	105	106	107	108	109	110
	12	Off	Off	Off	Off	On	Off	Off	Off	121	112	113	114	115	116	117	118	119	120
	13	Off	Off	Off	Off	Off	On	Off	Off	-	122	123	124	125	126	127	-	-	-

(1) P1- P10: Button 1 - button 10.

Important: Select a different configuration option for each EL610D module.

(*) **Factory setting.**

IMPORTANT:

- For description, installation, configuration and programming of the door panel, EL610D module and monitors, see the manuals supplied with the respective door panel and monitors.

- Up to 4 button access panels, see below:

Installation with 1 button access panel up to 128 apartments.

Installation with 2 button access panels up to 62 apartments on each access panel.

Installation with 3 button access panels up to 42 apartments on each access panel.

Installation with 4 button access panels up to 32 apartments on each access panel.

INSTALLATION

Continued from previous page.

EL610D button module

Single button module codes

		DIP switch								Button code					(1)
		Dip1	Dip2	Dip3	Dip4	Dip5	Dip6	Dip7	Dip8	P1	P3	P5	P7	P9	
Module configuration option	1	On	Off	Off	Off	Off	Off	Off	On	1	2	3	4	5	(*)
	2	Off	On	Off	Off	Off	Off	Off	On	6	7	8	9	10	
	3	Off	Off	On	Off	Off	Off	Off	On	11	12	13	14	15	
	4	Off	Off	Off	On	Off	Off	Off	On	16	17	18	19	20	
	5	Off	Off	Off	Off	On	Off	Off	On	21	22	23	24	25	
	6	Off	Off	Off	Off	Off	On	Off	On	26	27	28	29	30	
	7	Off	Off	Off	Off	Off	Off	On	On	31	32	33	34	35	
	8	On	Off	Off	Off	Off	Off	Off	Off	36	37	38	39	40	
	9	Off	On	Off	Off	Off	Off	Off	Off	41	42	43	44	45	
	10	Off	Off	On	Off	Off	Off	Off	Off	46	47	48	49	50	
	11	Off	Off	Off	On	Off	Off	Off	Off	51	52	53	54	55	
	12	Off	Off	Off	Off	On	Off	Off	Off	56	57	58	59	60	
	13	Off	Off	Off	Off	Off	On	Off	Off	61	62	63	64	65	
	14	Off	Off	Off	Off	Off	Off	On	Off	66	67	68	69	70	

(1) P1- P10: Button 1 - button 10.

Important: Select a different configuration option for each EL610D module.

(*) **Factory setting.**

IMPORTANT:

- For description, installation, configuration and programming of the door panel, EL610D module and monitors, see the manuals supplied with the respective door panel and monitors.
- Up to 4 button access panels, see below:
 - Installation with 1 button access panel up to 71 apartments.
 - Installation with 2 button access panels up to 31 apartments on each access panel.
 - Installation with 3 button access panels up to 21 apartments on each access panel.
 - Installation with 4 button access panels up to 16 apartments on each access panel.

INSTALLATION

Configuring double button module codes (up to 128 addresses/apartments):

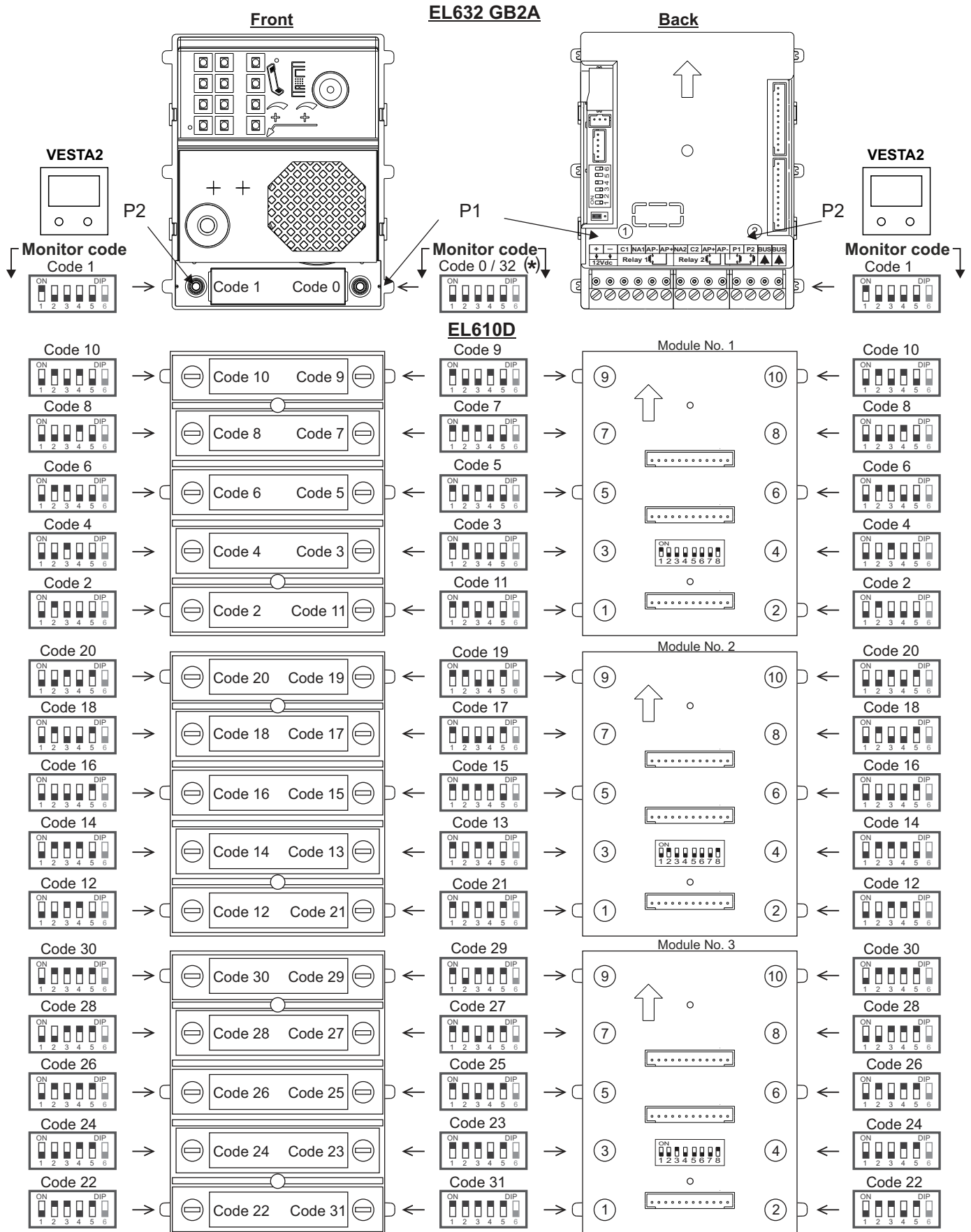

(*) -In door panel systems with call buttons, the first address on the monitor is 'Code 0'.

-In the software (Address Manager GB2), call 'code 0' of button 'P1' on the sound module is also shown as 'code 32'.

Continued overleaf

INSTALLATION

Continued from previous page.

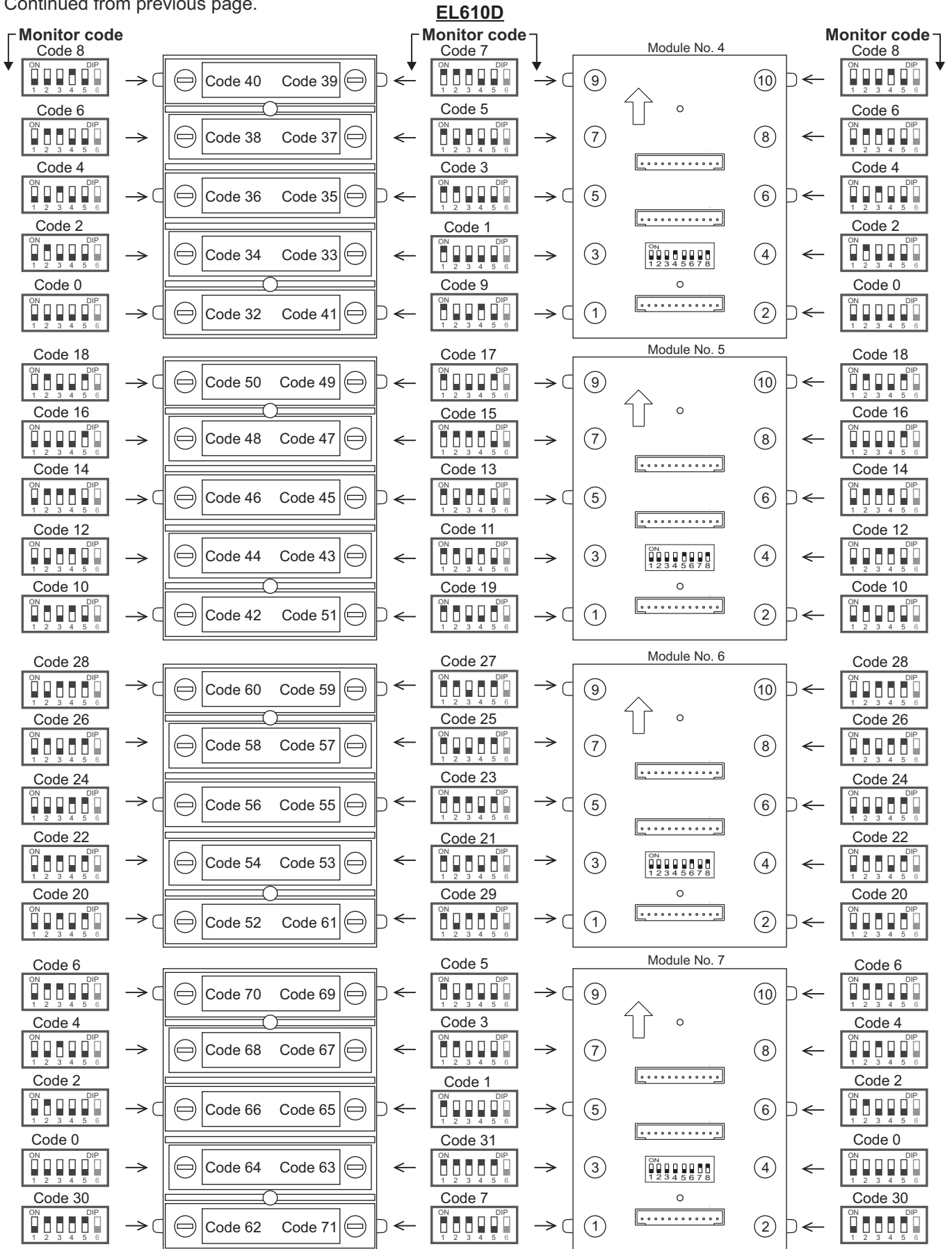

Continued overleaf

INSTALLATION

Continued from previous page.

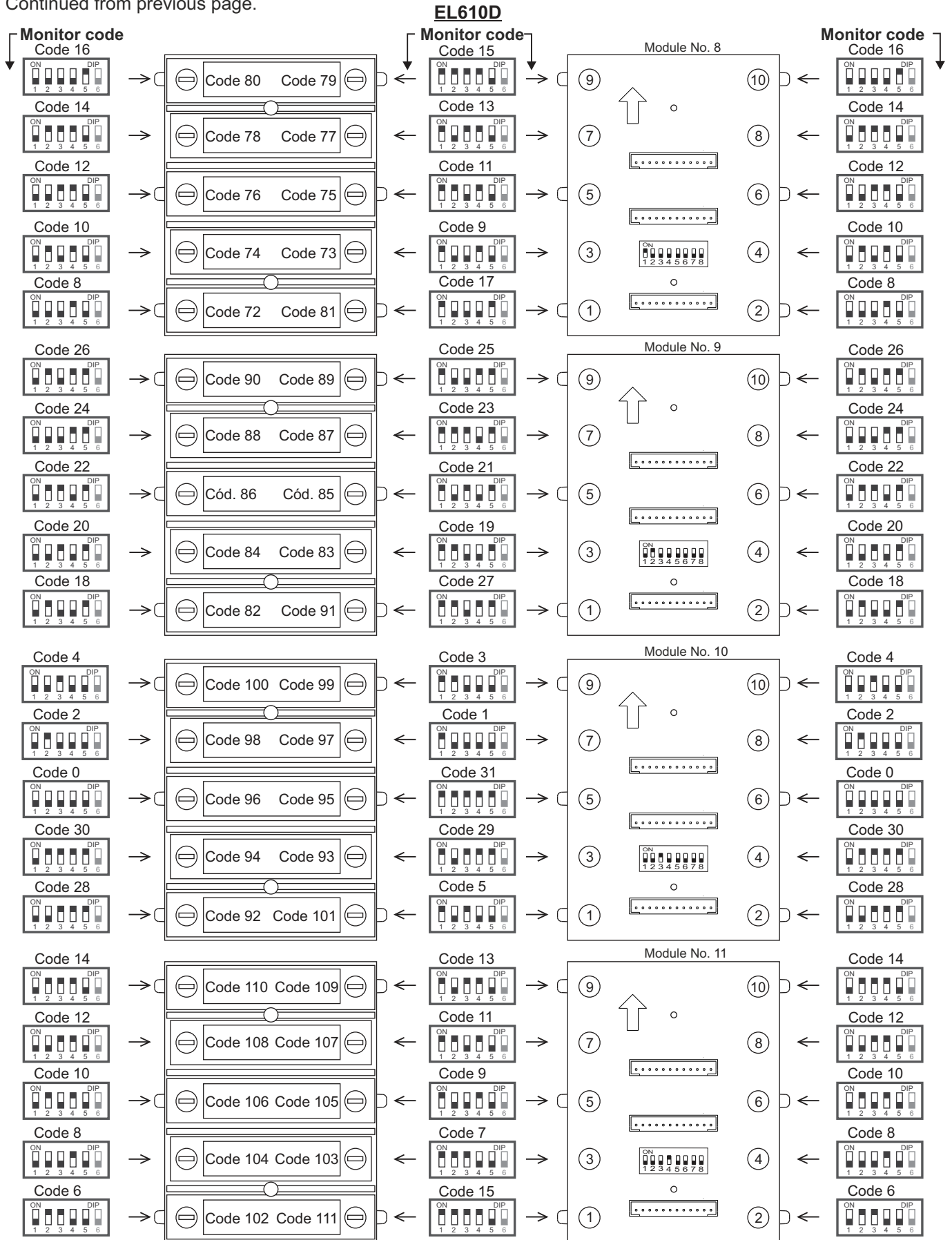

INSTALLATION

Continued from previous page.

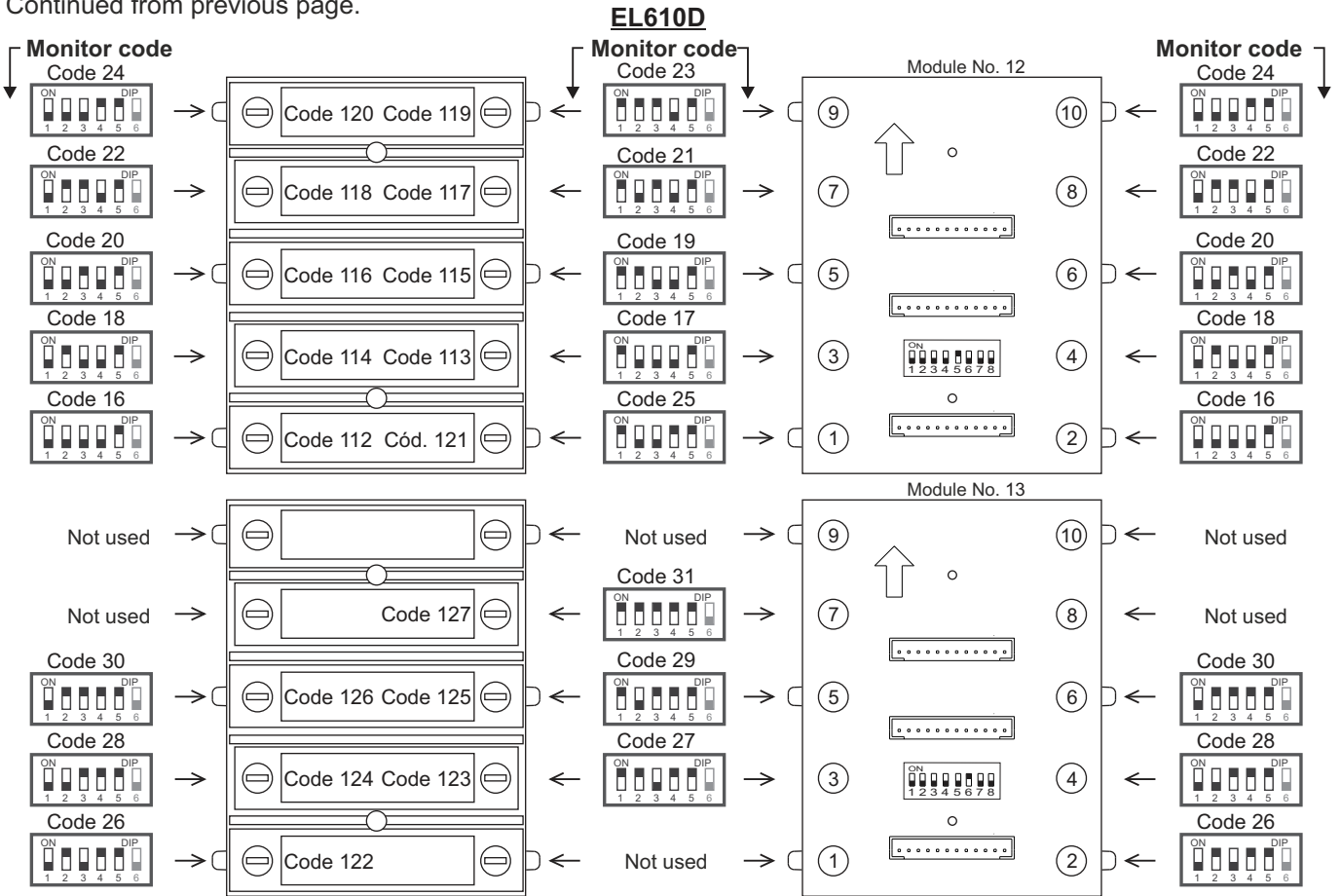

INSTALLATION

Continued from previous page.

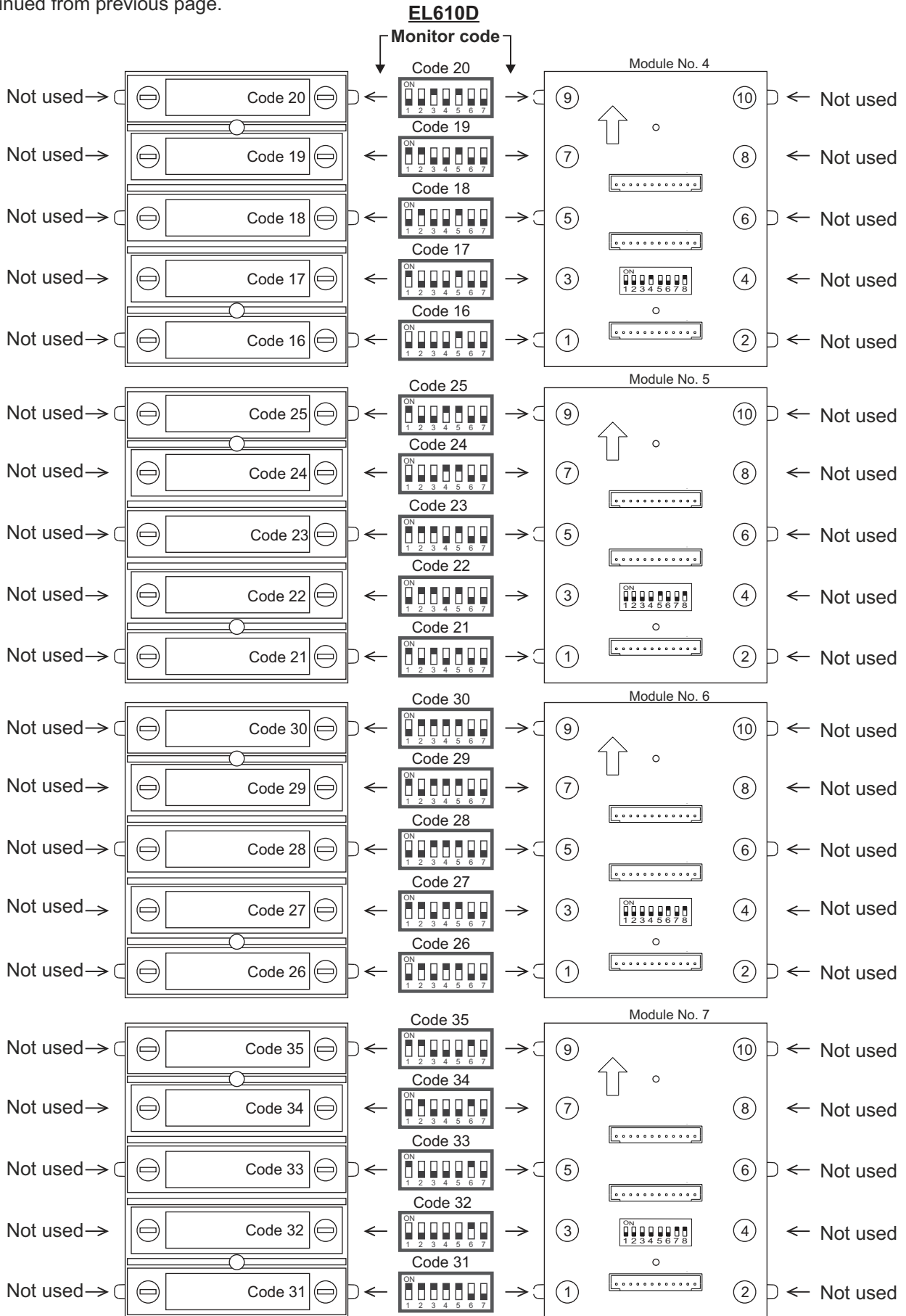

Continued overleaf

INSTALLATION

Continued from previous page.

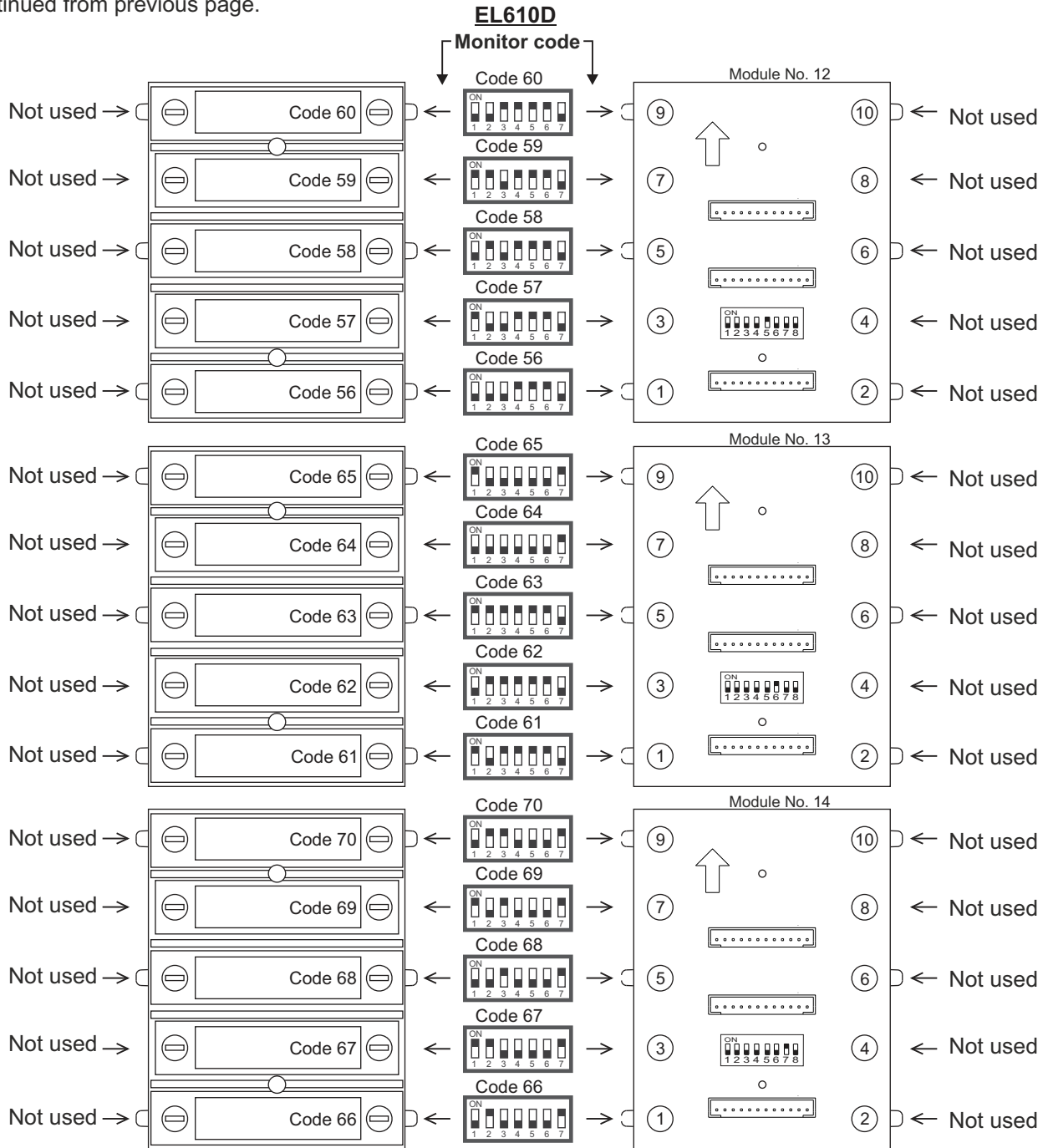

WIRING DIAGRAMS:

Installation of a video door entry system with RD-GB2A 'repeater' mode (increase the distance of the monitor Bus).

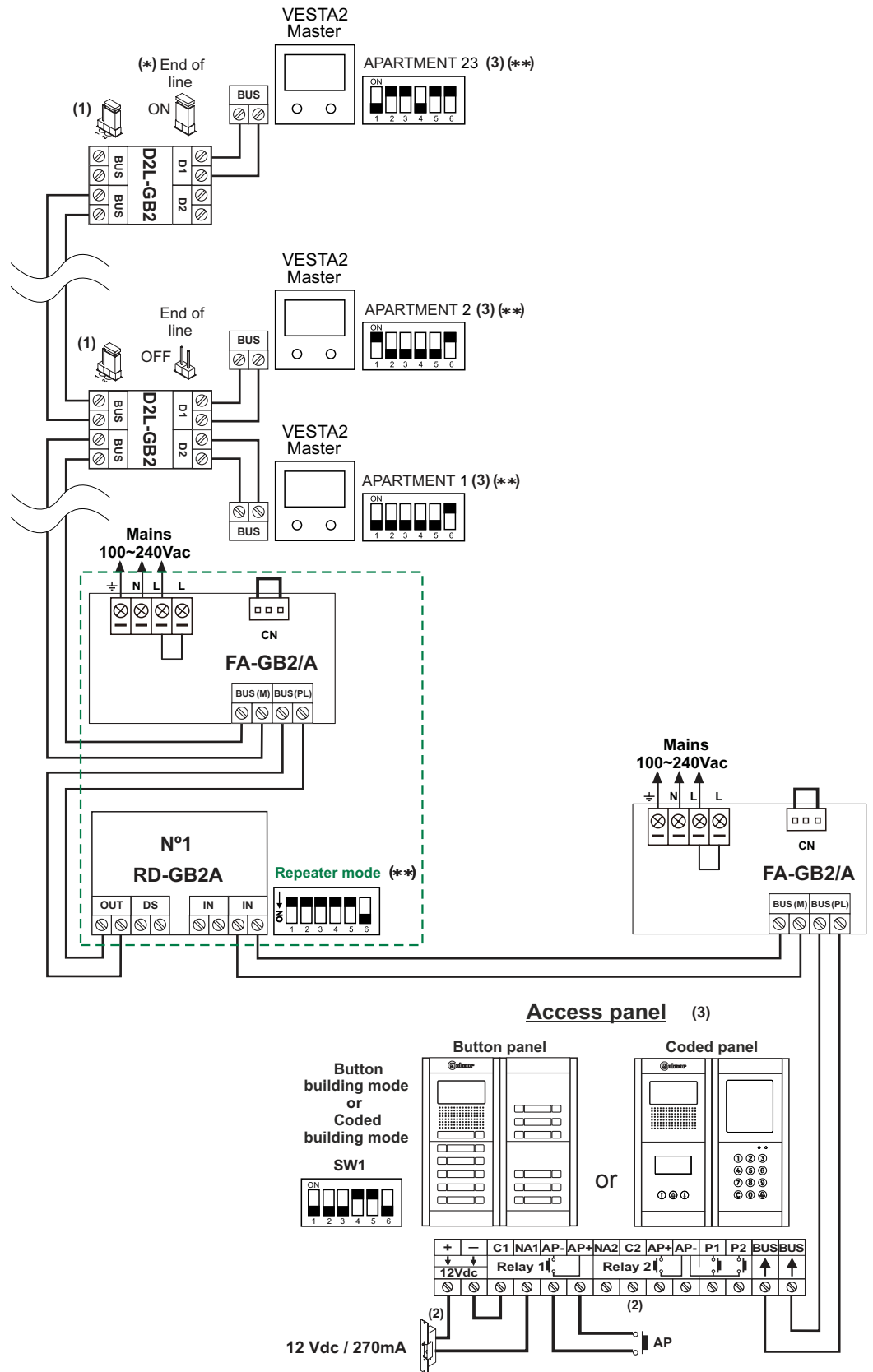

Important:

- (1) Leave the jumper in this position for 4,3" GB2 monitors of all of the D2L-GB2 distributors.
- (2) For the connection of an AC lock release or a 2nd lock release, see page 37.
- (3) For description, installation, configuration and programming of the monitor and door panel, see the corresponding manual.

Note: Cross-sections and distances table see page 4.

WIRING DIAGRAMS:

Installation of a video door entry system with RD-GB2A 'repeater' mode (increase the distance of the door panel Bus).

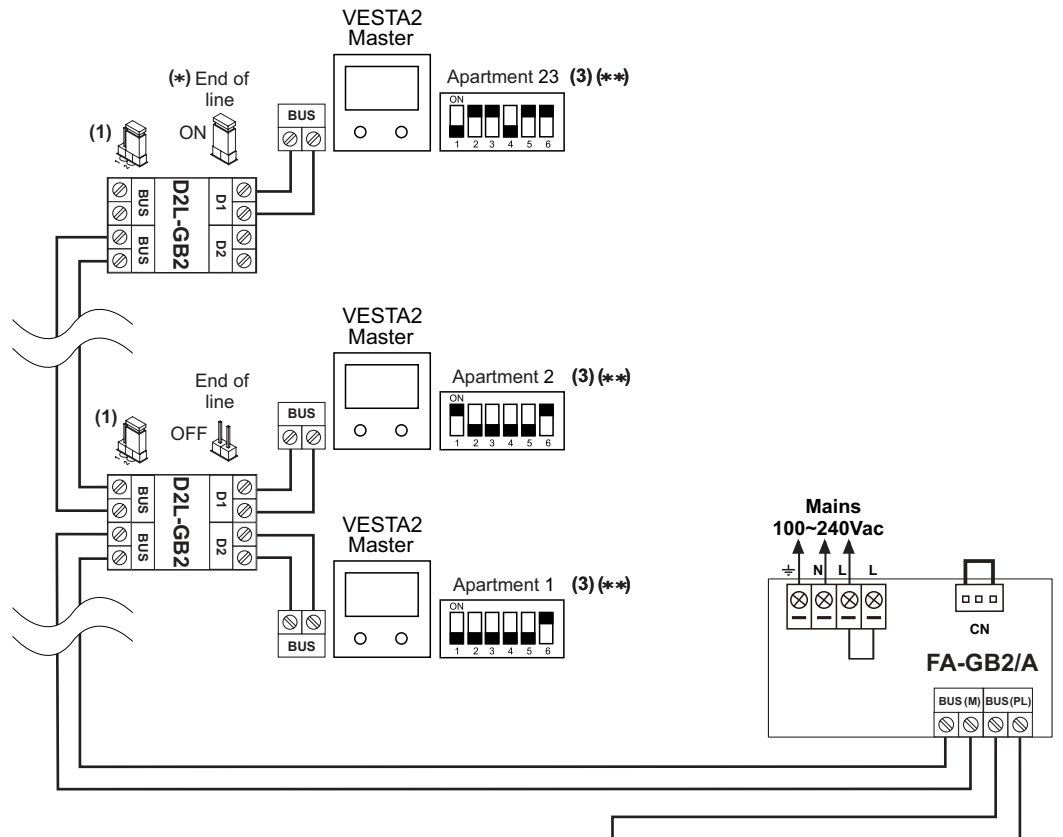

(*) Remove the jumper from all of the distributors except the last.

(**) Configure the end of line on the last monitor/RD-GB2A. DIP 6 to ON.

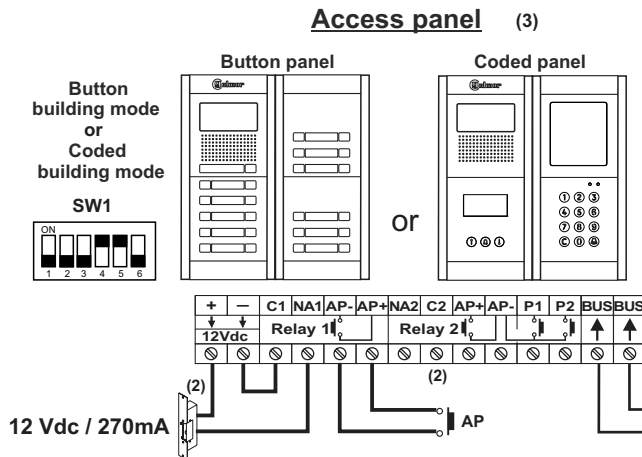
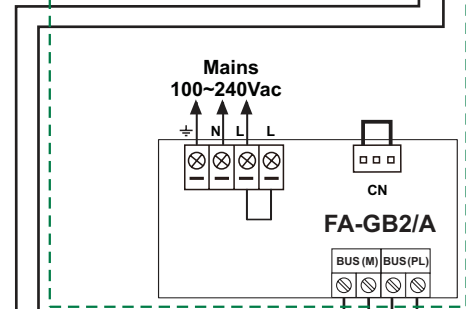
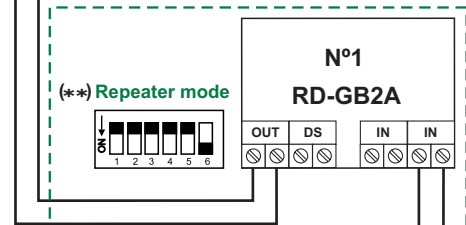

Important:

- (1) Leave the jumper in this position for 4,3" GB2 monitors of all of the D2L-GB2 distributors.
- (2) For the connection of an AC lock release or a 2nd lock release, see page 37.
- (3) For description, installation, configuration and programming of the monitor and door panel, see the corresponding manual.

Note: Cross-sections and distances table see page 4.

WIRING DIAGRAMS:

Installation of a video door entry system with RD-GB2A 'router' mode (enables up to 8 risers/verticals).

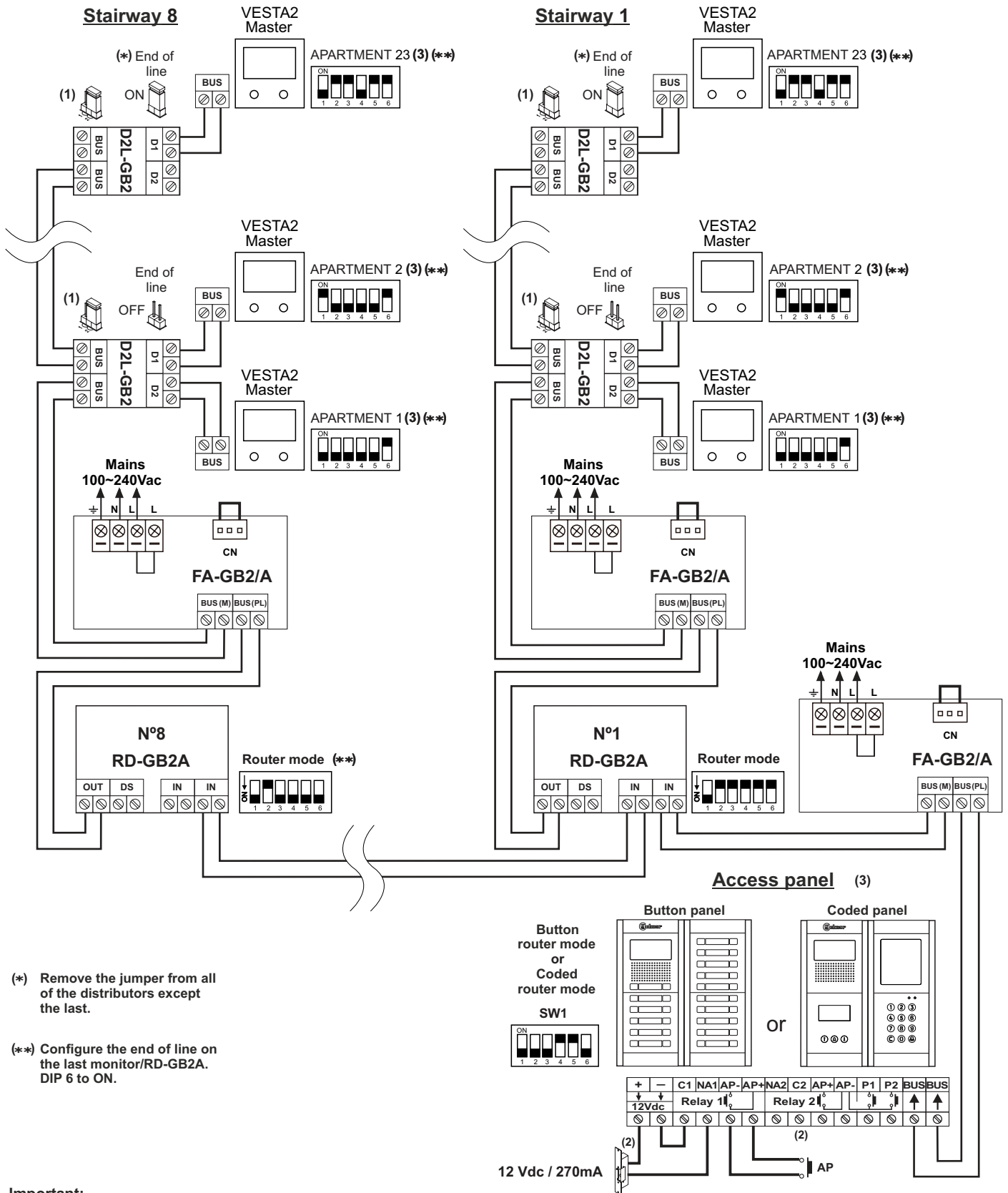

Important:

- (1) Leave the jumper in this position for 4,3" GB2 monitors of all of the D2L-GB2 distributors.
- (2) For the connection of an AC lock release or a 2nd lock release, see page 37.
- (3) For description, installation, configuration and programming of the monitor and door panel, see the corresponding manual.

Note: Number of door panels, cross-sections and distances table see p. 5.

WIRING DIAGRAMS:

Installation of a video door entry system with RD-GB2A 'gateway' mode (general entrance door panel and up to 8 interior buildings).

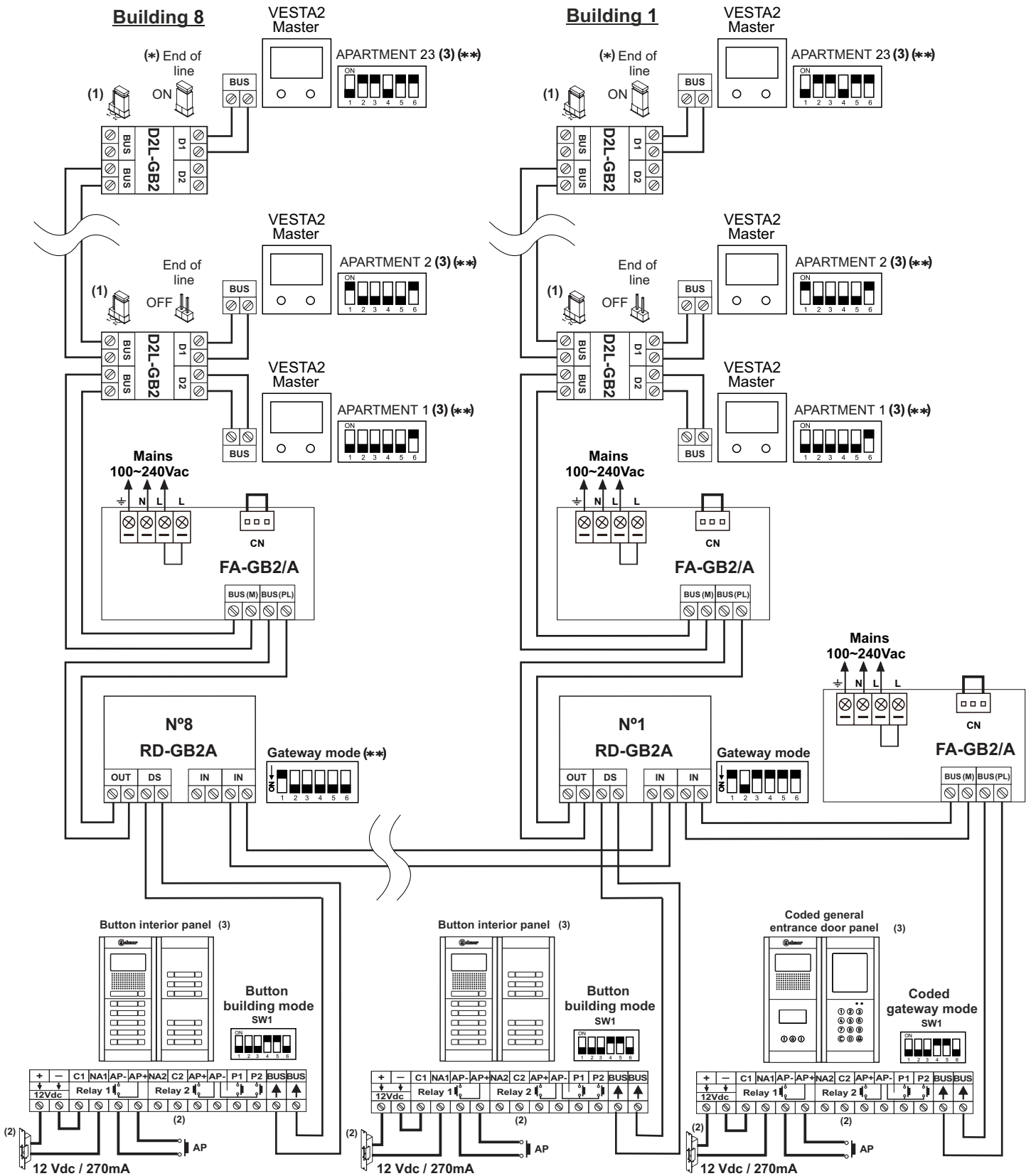

(*) Remove the jumper from all of the distributors except the last.

(**) Configure the end of line on the last monitor/RD-GB2A. DIP 6 to ON.

Note: Cross-sections and distances table see page 6.

Important:

- (1) Leave the jumper in this position for 4,3" GB2 monitors of all of the D2L-GB2 distributors.
- (2) For the connection of an AC lock release or a 2nd lock release, see page 37.
- (3) For description, installation, configuration and programming of the monitor and door panel, see the corresponding manual.

WIRING DIAGRAMS:

Installation of a video door entry system with RD-GB2A 'gateway' mode (general entrance door panel and up to 8 interior buildings).

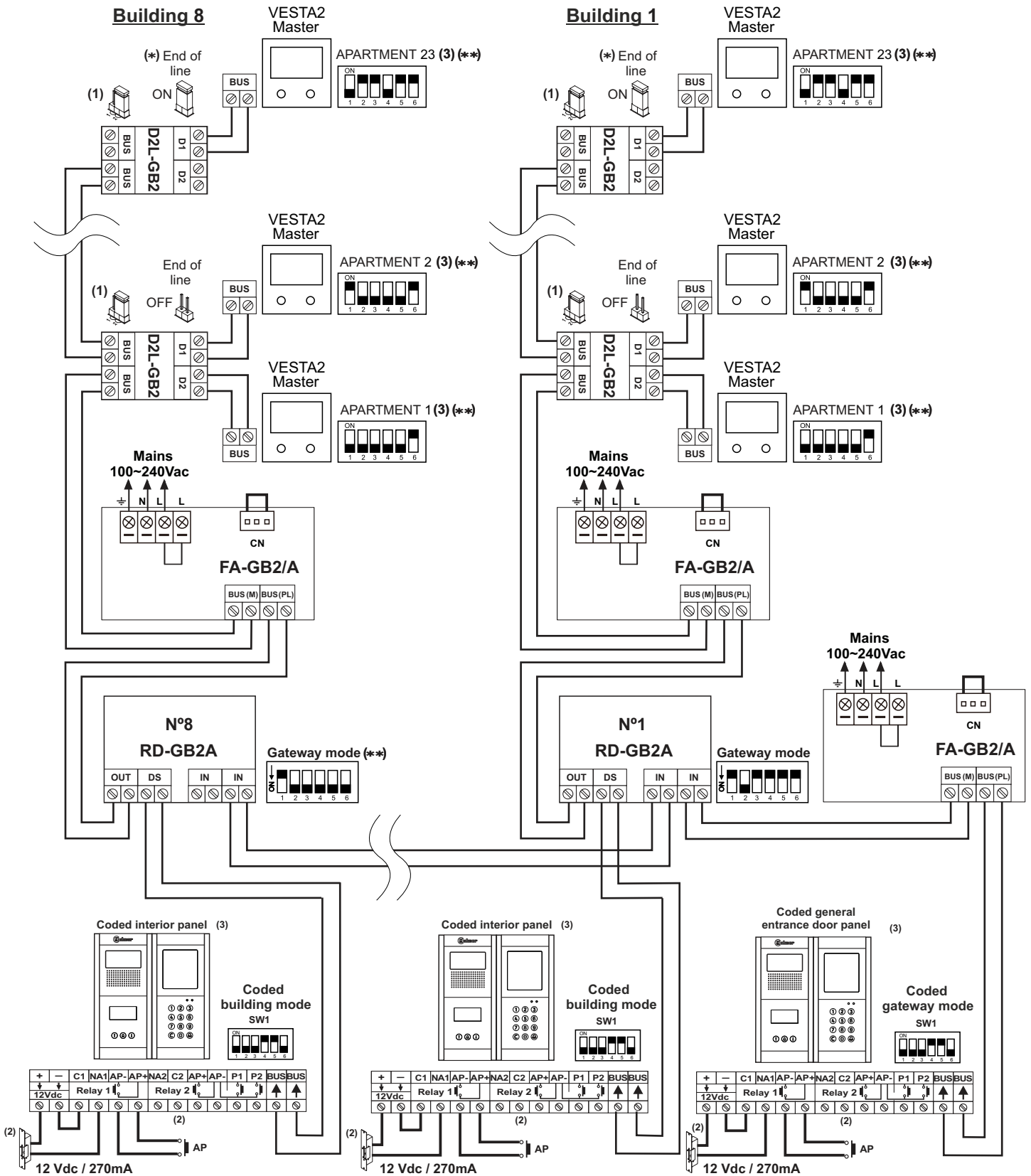

(*) Remove the jumper from all of the distributors except the last.
 (**) Configure the end of line on the last monitor/RD-GB2A. DIP 6 to ON.

Note: Cross-sections and distances table see page 6.

Important:

- (1) Leave the jumper in this position for 4,3" GB2 monitors of all of the D2L-GB2 distributors.
- (2) For the connection of an AC lock release or a 2nd lock release, see page 37.
- (3) For description, installation, configuration and programming of the monitor and door panel, see the corresponding manual.

WIRING DIAGRAMS:

Installation of a video door entry system with 4 access panels, DP-GB2A distributor for door panels and Golmar DC lock release.

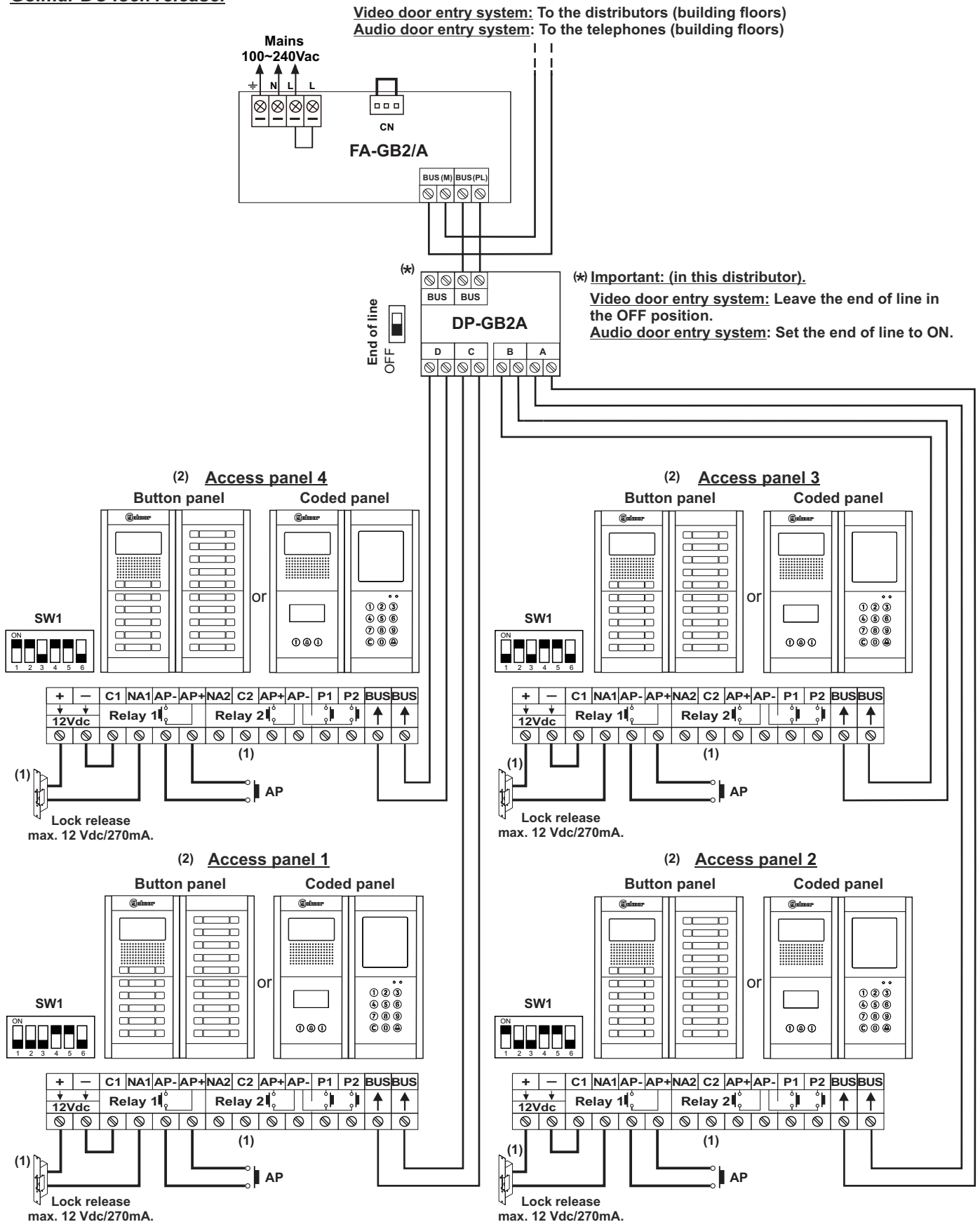

(1) Important: For the connection of an AC lock release or a 2nd lock release, see page 37.
 (2) Important: For description, installation, configuration and programming of the door panel, see the respective manual.
 To connect more than one button access panel, see characteristics page 3.

WIRING DIAGRAMS:

Connection of Golmar DC and AC lock releases.

Connection of 2 DC lock releases without 'AP':

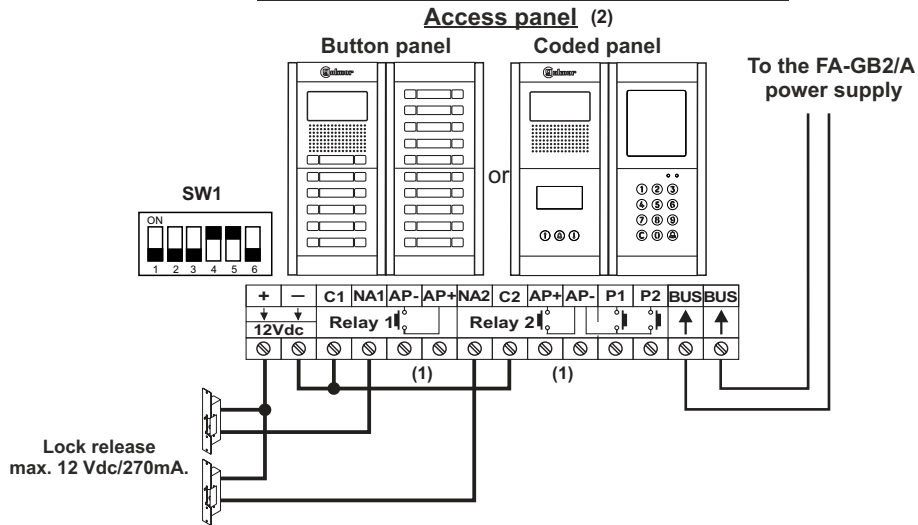

(1) Important: With 2 DC lock releases, it is not possible to use the "AP" door release buttons.

Connection of 1 AC lock release with 'AP':

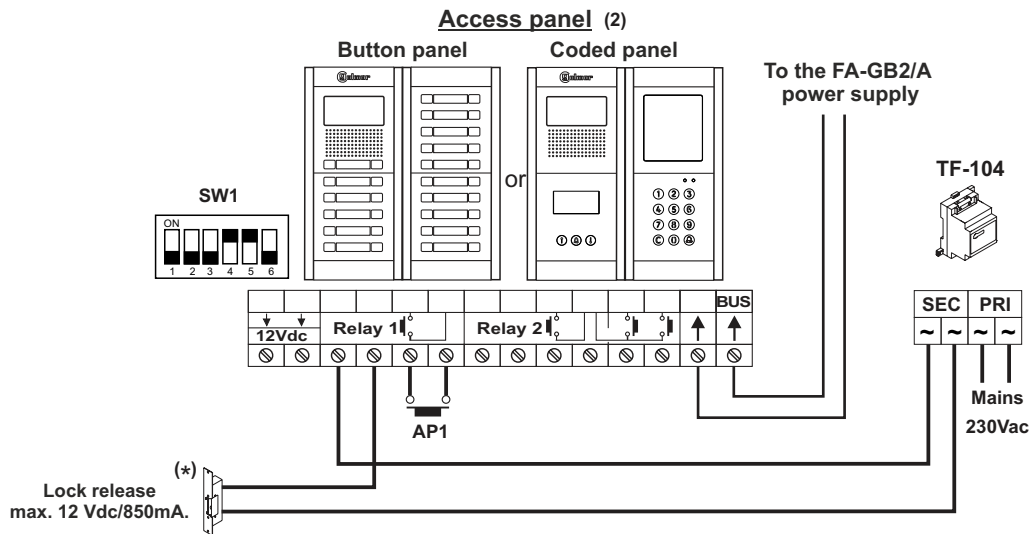

(*) Important: Place the varistor supplied with the sound module directly onto the terminals of the lock release.

Connection of 2 AC lock release with 'AP':

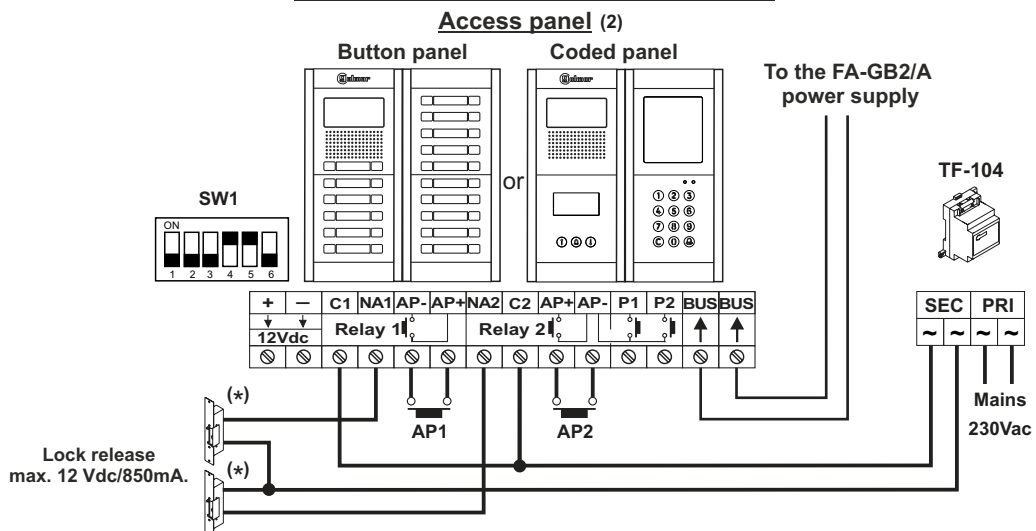

(*) Important: Place the varistors supplied with the sound module directly onto the terminals of the lock release.

(2) Important: For description, installation, configuration and programming of the monitor and door panel, see the corresponding manual.



1141 Budapest, Fogarasi út 77.

Tel.: *220-7940, 220-7814, 220-7959,
220-8881, 364-3428 Fax: 220-7940

Mobil: 30 531-5454, 30 939-9989

1095 Budapest, Mester utca 34.

Tel.: *218-5542, 215-9771, 215-7550,
216-7017, 216-7018 Fax: 218-5542

Mobil: 30 940-1970, 30 959-0930

www.golmar.hu

E-mail: info@delton.hu Web: www.delton.hu